

Bit Sockets, Bits & Screwdrivers

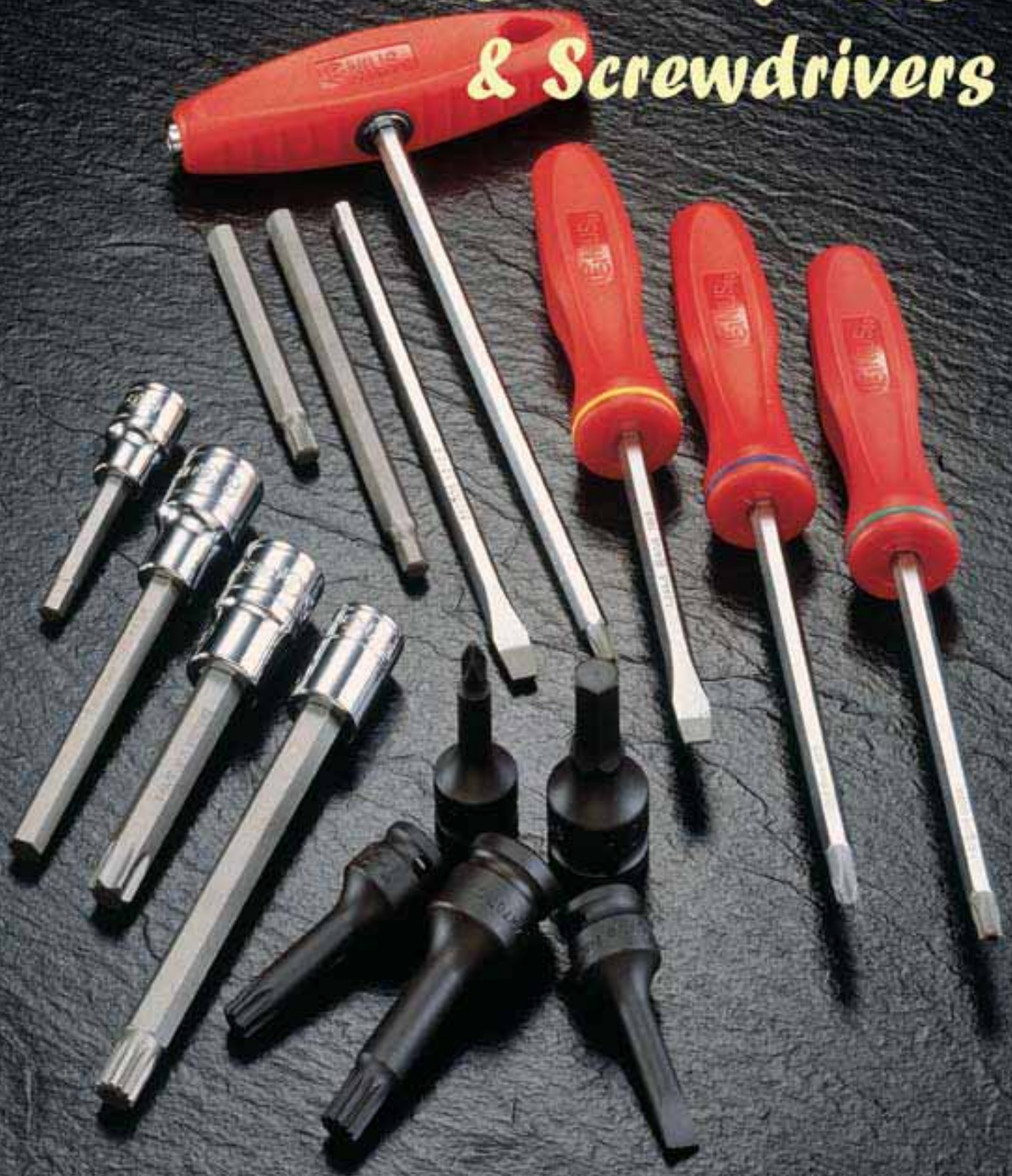

Metric Hex Head Drivers

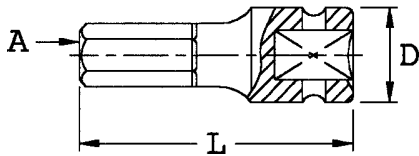

ITEM NO.	A mm	D mm	Length mm	Weight g	PCS 	G.W. KGS	CUFT 	CODE @
345204	4	19	52	35	200	8.0	0.60	000445
345205	5	19	52	40	200	9.0	0.60	000445
345206	6	19	52	40	200	9.0	0.60	000445
345207	7	19	52	50	200	11.0	0.60	000465
345208	8	19	52	55	200	12.0	0.60	000465
345209	9	19	52	60	200	13.0	0.60	000465
345210	10	19	52	60	200	13.0	0.60	000465
345212	12	19	52	80	200	17.0	0.60	000465
345214	14	19	52	95	200	20.0	0.60	000465
345216	16	20	52	105	200	22.0	0.60	000495
345217	17	20	52	115	200	24.0	0.60	000495

346004	4	19	60	49	200	11.0	0.60	000500
346005	5	19	60	49	200	11.0	0.60	000500
346006	6	19	60	49	200	11.0	0.60	000500
346007	7	19	60	56	200	12.5	0.60	000500
346008	8	19	60	56	200	12.5	0.60	000500
346009	9	19	60	62	200	13.5	0.60	000500
346010	10	19	60	70	200	15.0	0.60	000500
346012	12	19	60	82	200	17.5	0.60	000500
346014	14	19	60	96	200	20.5	0.60	000500
346016	16	20	60	118	200	24.5	0.60	000500
346017	17	20	60	120	200	25.0	0.60	000500

347604	4	19	76	55	140	9.0	0.44	000525
347605	5	19	76	55	140	9.0	0.44	000525
347606	6	19	76	55	140	9.0	0.44	000525
347607	7	19	76	65	140	10.0	0.44	000525
347608	8	19	76	70	140	11.0	0.44	000525
347609	9	19	76	80	140	12.5	0.44	000525
347610	10	19	76	100	140	15.0	0.44	000525
347612	12	19	76	105	140	16.0	0.44	000525
347614	14	19	76	130	140	19.5	0.44	000525
347616	16	20	76	155	140	23.0	0.44	000525
347617	17	20	76	160	140	23.5	0.44	000525

SAE Hex Head Drivers



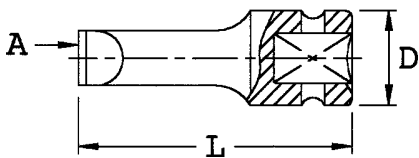

ITEM NO.	A Inch	D mm	Length mm	Weight g	PCS 	G.W. KGS	CUFT 	CODE @
365205	5/32	19	52	35	200	8.0	0.60	000475
365206	3/16	19	52	40	200	9.0	0.60	000475
365207	7/32	19	52	40	200	9.0	0.60	000475
365208	1/4	19	52	45	200	10.0	0.60	000500
365210	5/16	19	52	55	200	12.0	0.60	000500
365212	3/8	19	52	60	200	13.0	0.60	000500
365214	7/16	19	52	70	200	15.0	0.60	000500
365216	1/2	19	52	85	200	18.0	0.60	000500
365218	9/16	19	52	95	200	20.0	0.60	000500
365220	5/8	20	52	105	200	22.0	0.60	000525

Slotted Head Drivers





ITEM NO.	T x W mm	Size mm	Length mm	Weight g	PCS 	G.W. KGS	CUFT 	CODE @
3452P055	1.0 x 5.5	19	52	45	200	10.0	0.60	000475
3452P08	1.2 x 8.0	19	52	45	200	10.0	0.60	000475
3452P10	1.6 x 10.0	19	52	50	200	11.0	0.60	000475
3460P055	1.0 x 5.5	19	60	50	200	11.0	0.60	000500
3460P08	1.2 x 8.0	19	60	50	200	11.0	0.60	000500
3460P10	1.6 x 10.0	19	60	60	200	13.0	0.60	000500
3476P055	1.0 x 5.5	19	76	80	140	12.5	0.44	000525
3476P08	1.2 x 8.0	19	76	80	140	12.5	0.44	000525
3476P10	1.6 x 10.0	19	76	95	140	14.5	0.44	000525

★ Star Head Drivers

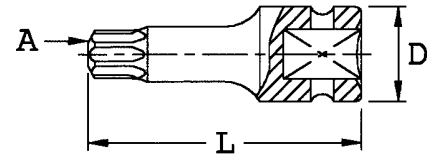
ITEM NO.	A Size	D mm	Length mm	Weight g	PCS 	G.W. KGS	CUFT 	CODE @
3452S10	T-10	19	52	45	200	10.0	0.60	000475
3452S15	T-15	19	52	45	200	10.0	0.60	000475
3452S20	T-20	19	52	45	200	10.0	0.60	000475
3452S25	T-25	19	52	45	200	10.0	0.60	000475
3452S27	T-27	19	52	45	200	10.0	0.60	000475
3452S30	T-30	19	52	45	200	10.0	0.60	000475
3452S40	T-40	19	52	45	200	10.0	0.60	000475
3452S45	T-45	19	52	50	200	10.5	0.60	000475
3452S50	T-50	20	52	50	200	11.0	0.60	000475
3452S55	T-55	20	52	60	200	13.0	0.60	000475
3452S60	T-60	20	52	70	200	15.0	0.60	000475
3460S10	T-10	19	60	50	200	11.0	0.60	000500
3460S15	T-15	19	60	50	200	11.0	0.60	000500
3460S20	T-20	19	60	50	200	11.0	0.60	000500
3460S25	T-25	19	60	50	200	11.0	0.60	000500
3460S27	T-27	19	60	50	200	11.0	0.60	000500
3460S30	T-30	19	60	50	200	11.0	0.60	000500
3460S40	T-40	19	60	50	200	11.0	0.60	000500
3460S45	T-45	19	60	60	200	13.0	0.60	000500
3460S50	T-50	20	60	65	200	14.0	0.60	000500
3460S55	T-55	20	60	70	200	15.0	0.60	000500
3460S60	T-60	20	60	80	200	17.0	0.60	000500
3476S10	T-10	19	76	75	140	11.5	0.44	000590
3476S15	T-15	19	76	75	140	11.5	0.44	000590
3476S20	T-20	19	76	75	140	11.5	0.44	000590
3476S25	T-25	19	76	75	140	11.5	0.44	000590
3476S27	T-27	19	76	80	140	12.5	0.44	000590
3476S30	T-30	19	76	80	140	12.5	0.44	000590
3476S40	T-40	19	76	80	140	12.5	0.44	000590
3476S45	T-45	19	76	85	140	13.0	0.44	000590
3476S50	T-50	20	76	90	140	14.0	0.44	000590
3476S55	T-55	20	76	115	140	17.0	0.44	000590
3476S60	T-60	20	76	135	140	20.0	0.44	000590



✚ Philips Head Drivers

ITEM NO.	A Size	D mm	Length mm	Weight g	PCS 	G.W. KGS	CUFT 	CODE @
3452R01	#1	19	52	45	200	10.0	0.60	000475
3452R02	#2	19	52	45	200	10.0	0.60	000475
3452R03	#3	19	52	45	200	10.0	0.60	000475
3452R04	#4	19	52	50	200	11.0	0.60	000475
3460R01	#1	19	60	50	200	11.0	0.60	000500
3460R02	#2	19	60	50	200	11.0	0.60	000500
3460R03	#3	19	60	50	200	11.0	0.60	000500
3460R04	#4	19	60	60	200	13.0	0.60	000500
3476R01	#1	19	76	75	140	11.5	0.44	000525
3476R02	#2	19	76	80	140	12.5	0.44	000525
3476R03	#3	19	76	80	140	12.5	0.44	000525
3476R04	#4	19	76	95	140	13.5	0.44	000525

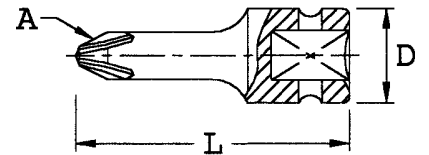

Triple Square Head Drivers

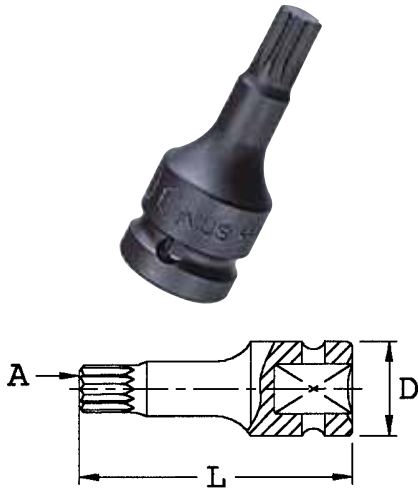

ITEM NO.	A Size	D mm	Length mm	Weight g	PCS 	G.W. KGS	CUFT 	CODE @
3452T05	M5	19	52	45.0	200	10.0	0.60	000475
3452T06	M6	19	52	45.0	200	10.0	0.60	000475
3452T08	M8	19	52	50.0	200	11.0	0.60	000475
3452T10	M10	20	52	60.0	200	13.0	0.60	000475
3452T12	M12	20	52	65.0	200	14.0	0.60	000475
3460T05	M5	19	60	50.0	200	11.0	0.60	000500
3460T06	M6	19	60	50.0	200	11.0	0.60	000500
3460T08	M8	19	60	55.0	200	12.0	0.60	000500
3460T10	M10	20	60	65.0	200	14.0	0.60	000500
3460T12	M12	20	60	75.0	200	16.0	0.60	000500
3476T05	M5	19	76	80.0	140	12.5	0.44	000525
3476T06	M6	19	76	80.0	140	12.5	0.44	000525
3476T08	M8	19	76	90.0	140	14.0	0.44	000525
3476T10	M10	20	76	110.0	140	16.5	0.44	000525
3476T12	M12	20	76	130.0	140	19.5	0.44	000525

TH-312S 12 Piece SAE Hex Head Driver Set

- Item No. Description**
3/8" Dr. Hex Head Driver:
 365205 5/32" Hex Head Driver
 365206 3/16" Hex Head Driver
 365207 7/32" Hex Head Driver
 365208 1/4" Hex Head Driver
 365210 5/16" Hex Head Driver
 365212 3/8" Hex Head Driver
 365214 7/16" Hex Head Driver
 365216 1/2" Hex Head Driver
 365218 9/16" Hex Head Driver
 365220 5/8" Hex Head Driver

Accessory:
 380030 Sliding T-Handle
 380333R Reversible Ratchet Handle
 Metal Box

1780 g **CODE : 008715**
 10 Sets / 19 Kgs / 0.77 CUFT

TH-312M 12 Piece Metric Hex Head Driver Set

- Item No. Description**
3/8" Dr. Hex Head Driver:
 345204 4mm Hex Head Driver
 345205 5mm Hex Head Driver
 345206 6mm Hex Head Driver
 345207 7mm Hex Head Driver
 345208 8mm Hex Head Driver
 345210 10mm Hex Head Driver
 345212 12mm Hex Head Driver
 345214 14mm Hex Head Driver
 345216 16mm Hex Head Driver
 345217 17mm Hex Head Driver

Accessory:
 380030 Sliding T-Handle
 380333R Reversible Ratchet Handle
 Metal Box

1780 g **CODE : 008400**
 10 Sets / 19 Kgs / 0.77 CUFT



**TH-312M
(TH-312S)**



TH-321M

TH-321M 21 Piece Metric Hex Head Driver Component Set

- | Item No. | Description | Item No. | Description |
|--------------------------------------|----------------------|---------------------------------------|--------------------------------|
| 3/8" Dr. Hex Head Driver: | | | |
| 346004 | 4mm Hex Head Driver | 3460P055 | 1.0 x 5.5 Slotted Head Driver |
| 346005 | 5mm Hex Head Driver | 3460P08 | 1.2 x 8.0 Slotted Head Driver |
| 346006 | 6mm Hex Head Driver | 3460P10 | 1.6 x 10.0 Slotted Head Driver |
| 346007 | 7mm Hex Head Driver | 3/8" Dr. Phillips Head Driver: | |
| 346008 | 8mm Hex Head Driver | 3460R01 | #1 Philips Head Driver |
| 346009 | 9mm Hex Head Driver | 3460R02 | #2 Philips Head Driver |
| 346010 | 10mm Hex Head Driver | 3460R03 | #3 Philips Head Driver |
| 346012 | 12mm Hex Head Driver | 3460R04 | #4 Philips Head Driver |
| 346014 | 14mm Hex Head Driver | Accessory: | |
| 346016 | 16mm Hex Head Driver | 340075 | Impact Extension Bar 75mmL |
| 346017 | 17mm Hex Head Driver | 380030 | Sliding T-Handle |
| 3/8" Dr. Slotted Head Driver: | | 380333R | Reversible Ratchet Handle |
| | | Metal Box | |

2660 g 6 Sets / 17 Kgs / 0.70 CUFT **CODE : 012120**

TH-310M 10 Piece Metric Hex Head Driver Set

Item No.	Description
3/8" Dr. Hex Head Driver:	
345204	4mm Hex Head Driver
345205	5mm Hex Head Driver
345206	6mm Hex Head Driver
345207	7mm Hex Head Driver
345208	8mm Hex Head Driver
345210	10mm Hex Head Driver
345212	12mm Hex Head Driver
345214	14mm Hex Head Driver
345216	16mm Hex Head Driver
345217	17mm Hex Head Driver

Metal Box

900 g CODE : 004650
 20 Sets / 19 Kgs / 0.88 CUFT

TH-310S 10 Piece SAE Hex Head Driver Set

Item No.	Description
3/8" Dr. Hex Head Driver:	
365205	5/32" Hex Head Driver
365206	3/16" Hex Head Driver
365207	7/32" Hex Head Driver
365208	1/4" Hex Head Driver
365210	5/16" Hex Head Driver
365212	3/8" Hex Head Driver
365214	7/16" Hex Head Driver
365216	1/2" Hex Head Driver
365218	9/16" Hex Head Driver
365220	5/8" Hex Head Driver

Metal Box

900 g CODE : 004950
 20 Sets / 19 Kgs / 0.88 CUFT

TM-305 5 Piece Triple Square Head Driver

Item No.	Description
3/8" Dr. Triple Square Head Driver:	
3476T05	M05 Triple Square Head Driver
3476T06	M06 Triple Square Head Driver
3476T08	M08 Triple Square Head Driver
3476T10	M10 Triple Square Head Driver
3476T12	M12 Triple Square Head Driver

Metal Box

650 g CODE : 002625
 20 Sets / 14 Kgs / 0.67 CUFT

TX-321 21 Piece Star Head Driver Component Set

Item No.	Description
3/8" Dr. Star Type Head Driver:	
3460S10	T-10 Star Head Driver
3460S15	T-15 Star Head Driver
3460S20	T-20 Star Head Driver
3460S25	T-25 Star Head Driver
3460S27	T-27 Star Head Driver
3460S30	T-30 Star Head Driver
3460S40	T-40 Star Head Driver
3460S45	T-45 Star Head Driver
3460S50	T-50 Star Head Driver
3460S55	T-55 Star Head Driver
3460S60	T-60 Star Head Driver
3/8" Dr. Philips Head Driver:	
3460R01	#1 Philips Head Driver
3460R02	#2 Philips Head Driver
3460R03	#3 Philips Head Driver
3460R04	#4 Philips Head Driver
3/8" Dr. Slotted Head Driver:	
3460P055	1.0 x 5.5 Slotted Head Driver
3460P08	1.2 x 8.0 Slotted Head Driver
3460P10	1.6 x 10 Slotted Head Driver

Accessory:

340075	Impact Extension Bar 75mmL
380030	Sliding T-Handle
380333R	Reversible Ratchet Handle

Metal Box

2460 g CODE : 012120
 6 Sets / 16 Kgs / 0.70 CUFT

TM-305





TH-310M
(TH-310S)

TX-321





Metric Hex Head Drivers

ITEM NO.	A mm	D mm	Length mm	Weight g	PCS 	G.W. KGS	CUFT 	CODE @
446004	4	24	60	70	140	11.0	0.44	000590
446005	5	24	60	70	140	11.0	0.44	000590
446006	6	24	60	70	140	11.0	0.44	000590
446007	7	24	60	75	140	11.5	0.44	000590
446008	8	24	60	75	140	11.5	0.44	000590
446009	9	24	60	80	140	12.5	0.44	000590
446010	10	26	60	85	140	13.0	0.44	000590
446012	12	26	60	95	140	14.5	0.44	000590
446014	14	26	60	110	120	14.5	0.52	000590
446016	16	28	60	160	120	20.5	0.52	000650
446017	17	28	60	160	120	20.5	0.52	000650
446019	19	28	60	175	120	22.0	0.52	000650
446021	21	28	60	210	120	26.5	0.52	000650

447604	4	24	76	75	140	11.5	0.44	000735
447605	5	24	76	75	140	11.5	0.44	000735
447606	6	24	76	80	140	12.5	0.44	000735
447607	7	24	76	85	140	13.0	0.44	000735
447608	8	24	76	85	140	13.0	0.44	000735
447609	9	24	76	90	140	14.0	0.44	000735
447610	10	26	76	100	140	15.0	0.44	000735
447612	12	26	76	115	140	17.0	0.44	000735
447614	14	26	76	135	120	17.5	0.52	000735
447616	16	28	76	200	120	25.0	0.52	000885
447617	17	28	76	205	120	26.0	0.52	000885
447619	19	28	76	240	120	30.0	0.52	000885
447621	21	28	76	270	120	33.0	0.52	000885



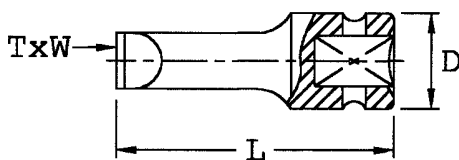
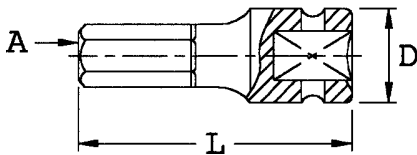

SAE Hex Head Drivers

ITEM NO.	A Inch	D mm	Length mm	Weight g	PCS 	G.W. KGS	CUFT 	CODE @
466005	5/32	24	60	65	140	10.5	0.44	000590
466006	3/16	24	60	65	140	10.5	0.44	000590
466007	7/32	24	60	70	140	11.0	0.44	000590
466008	1/4	24	60	70	140	11.0	0.44	000590
466010	5/16	24	60	75	140	11.5	0.44	000590
466012	3/8	26	60	85	140	13.0	0.44	000650
466014	7/16	26	60	95	140	14.5	0.44	000650
466016	1/2	26	60	95	140	14.5	0.44	000650
466018	9/16	26	60	105	120	14.0	0.52	000650
466020	5/8	28	60	150	120	19.0	0.52	000650
466022	11/16	28	60	160	120	20.5	0.52	000650
466024	3/4	28	60	175	120	22.0	0.52	000650
466026	13/16	28	60	190	120	24.0	0.52	000650



Slotted Head Drivers

ITEM NO.	T x W mm	D mm	Length mm	Weight g	PCS 	G.W. KGS	CUFT 	CODE @
4460P08	1.2 x 8.0	24	60	70	140	11.0	0.44	000590
4460P10	1.6 x 10	24	60	80	140	12.5	0.44	000590
4460P12	2.0 x 12	24	60	85	140	13.0	0.44	000590
4460P14	2.5 x 14	24	60	95	140	14.5	0.44	000590
4460P16	2.5 x 16	24	60	100	140	15.0	0.44	000590
4476P08	1.2 x 8.0	24	76	80	140	12.5	0.44	000735
4476P10	1.6 x 10	24	76	85	140	13.0	0.44	000735
4476P12	2.0 x 12	24	76	100	140	15.0	0.44	000735
4476P14	2.5 x 14	24	76	115	140	17.5	0.44	000735
4476P16	2.5 x 16	24	76	130	140	19.5	0.44	000735

★ Star Head Drivers

ITEM NO.	A Size	D mm	Length mm	Weight g	PCS	G.W. KGS	CUFT	CODE @
4460S10	T-10	24	60	70	140	11.0	0.44	000590
4460S15	T-15	24	60	70	140	11.0	0.44	000590
4460S20	T-20	24	60	70	140	11.0	0.44	000590
4460S25	T-25	24	60	70	140	11.0	0.44	000590
4460S27	T-27	24	60	70	140	11.0	0.44	000590
4460S30	T-30	24	60	75	140	11.5	0.44	000590
4460S40	T-40	24	60	75	140	11.5	0.44	000590
4460S45	T-45	24	60	75	140	11.5	0.44	000590
4460S50	T-50	26	60	75	140	11.5	0.44	000590
4460S55	T-55	26	60	85	140	13.0	0.44	000590
4460S60	T-60	26	60	95	140	14.5	0.44	000590
4460S70	T-70	26	60	110	140	16.5	0.44	000590



4476S10	T-10	24	76	70	140	11.0	0.44	000735
4476S15	T-15	24	76	70	140	11.0	0.44	000735
4476S20	T-20	24	76	70	140	11.0	0.44	000735
4476S25	T-25	24	76	70	140	11.0	0.44	000735
4476S27	T-27	24	76	70	140	11.0	0.44	000735
4476S30	T-30	24	76	75	140	11.5	0.44	000735
4476S40	T-40	24	76	75	140	11.5	0.44	000735
4476S45	T-45	24	76	75	140	11.5	0.44	000735
4476S50	T-50	26	76	75	140	11.5	0.44	000735
4476S55	T-55	26	76	85	140	13.0	0.44	000735
4476S60	T-60	26	76	95	140	14.5	0.44	000735
4476S70	T-70	26	76	110	140	16.5	0.44	000735

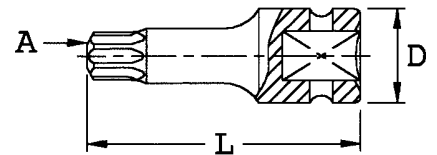

✚ Philips Head Drivers

ITEM NO.	A Size	D mm	Length mm	Weight g	PCS	G.W. KGS	CUFT	CODE @
4460R01	#1	24	60	70	140	11.0	0.44	000590
4460R02	#2	24	60	70	140	11.0	0.44	000590
4460R03	#3	24	60	70	140	11.0	0.44	000590
4460R04	#4	24	60	80	140	12.5	0.44	000590
4476R01	#1	24	76	75	140	11.5	0.44	000735
4476R02	#2	24	76	75	140	11.5	0.44	000735
4476R03	#3	24	76	80	140	12.5	0.44	000735
4476R04	#4	24	76	85	140	13.0	0.44	000735

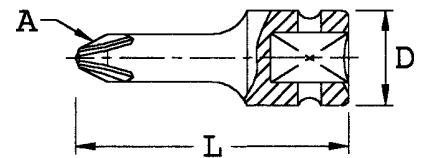

★ Triple Square Head Drivers

ITEM NO.	A Size	D mm	Length mm	Weight g	PCS	G.W. KGS	CUFT	CODE @
4460T05	M05	24	60	70	140	11.0	0.44	000590
4460T06	M06	24	60	70	140	11.0	0.44	000590
4460T08	M08	24	60	70	140	11.0	0.44	000590
4460T10	M10	26	60	85	140	12.5	0.44	000590
4460T12	M12	26	60	90	140	13.5	0.44	000590
4476T05	M05	24	76	75	140	11.5	0.44	000735
4476T06	M06	24	76	75	140	11.5	0.44	000735
4476T08	M08	24	76	85	140	12.5	0.44	000735
4476T10	M10	26	76	95	140	14.5	0.44	000735
4476T12	M12	26	76	110	140	16.0	0.44	000735
4476T14	M14	26	76	135	120	17.5	0.52	000735
4476T16	M16	28	76	200	120	25.0	0.52	000885

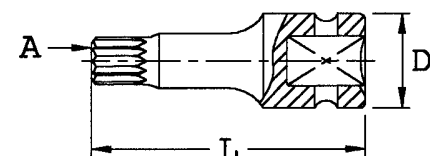



Head Driver Sets

TH-412H 12 Piece Metric Hex Head Driver Set

Item No.	Description
1/2" Dr. Hex Head Driver:	
446004	4mm Hex Head Driver
446005	5mm Hex Head Driver
446006	6mm Hex Head Driver
446008	8mm Hex Head Driver
446010	10mm Hex Head Driver
446012	12mm Hex Head Driver
446014	14mm Hex Head Driver
446017	17mm Hex Head Driver
446019	19mm Hex Head Driver

Accessory:

480032CM	Extension Bar 75mmL
480040	Sliding T-Handle
480444R	Reversible Ratchet Handle Blow Case

2830 g CODE : 011550
6 Sets / 18 Kgs / 1.16 CUFT

TH-412S 12 Piece SAE Hex Head Driver Set

Item No.	Description
1/2" Dr. Hex Head Driver:	
466005	5/32" Hex Head Driver
466006	3/16" Hex Head Driver
466008	1/4" Hex Head Driver
466010	5/16" Hex Head Driver
466012	3/8" Hex Head Driver
466014	7/16" Hex Head Driver
466016	1/2" Hex Head Driver
466020	5/8" Hex Head Driver
466024	3/4" Hex Head Driver

Accessory:

480032CM	Extension Bar 3"L
480040	Sliding T-Handle
480444R	Reversible Ratchet Handle Blow Case

2830 g CODE : 011550
6 Sets / 18 Kgs / 1.16 CUFT

TH-415H 15 Piece Metric Hex Head Driver Set

Item No.	Description
1/2" Dr. Hex Head Driver:	
446004	4mm Hex Head Driver
446005	5mm Hex Head Driver
446006	6mm Hex Head Driver
446008	8mm Hex Head Driver
446010	10mm Hex Head Driver
446012	12mm Hex Head Driver
446014	14mm Hex Head Driver
446017	17mm Hex Head Driver
446019	19mm Hex Head Driver

Screwdriver Bit:

700288	1.2 x 8.0 Slotted Bit
700290	1.6 x 10.0 Slotted Bit
700292	#2 Philips Bit
700293	#3 Philips Bit

Accessory:

464110	1/2" Dr. 5/16" Hex Bit Holder
700008	1/2" Dr. Impact Driver

Metal Box

3000 g CODE : 009900
6 Sets / 19 Kgs / 0.65 CUFT

TH-412H
(TH-412S)

TH-415H

TX-415 15 Piece Star Head Driver Component Set

Item No. Description

Item No.	Description
1/2" Dr. Star Head Driver:	
4460S10	T-10 Star Head Driver
4460S15	T-15 Star Head Driver
4460S20	T-20 Star Head Driver
4460S25	T-25 Star Head Driver
4460S27	T-27 Star Head Driver
4460S30	T-30 Star Head Driver
4460S40	T-40 Star Head Driver
4460S45	T-45 Star Head Driver
4460S50	T-50 Star Head Driver
4460S55	T-55 Star Head Driver
4460S60	T-60 Star Head Driver
4460S70	T-70 Star Head Driver

Accessory:

480032CM	Impact Extension Bar 75mmL
480040	Sliding T-Handle
480444R	Reversible Ratchet Handle

Metal Box

3160 g CODE : 011400
6 Sets / 20 Kgs / 0.70 CUFT

TM-405 5 Piece Triple Square Head Driver Set

Item No. Description

Item No.	Description
1/2" Dr. Triple Square Head Driver:	
4476T05	M05 Triple Square Head Driver
4476T06	M06 Triple Square Head Driver
4476T08	M08 Triple Square Head Driver
4476T10	M10 Triple Square Head Driver
4476T12	M12 Triple Square Head Driver

Metal Box

700 g CODE : 003675
20 Sets / 15 Kgs / 0.67 CUFT



TX-415



TM-405

Head Driver Sets

1/2

3/4

TH-408M 8 Piece 1/2"Dr. Metric Hex Head Driver Set

Item No.	Description
1/2" Dr. Hex Head Driver:	
446005	5mm Hex Head Driver
446006	6mm Hex Head Driver
446008	8mm Hex Head Driver
446010	10mm Hex Head Driver
446012	12mm Hex Head Driver
446014	14mm Hex Head Driver
446017	17mm Hex Head Driver
446019	19mm Hex Head Driver

Metal Box

1200 g CODE : 005330
20 Sets / 25 Kgs / 0.88 CUFT

TH-408S 8 Piece 1/2"Dr. SAE Hex Head Driver Set

Item No.	Description
1/2" Dr. Hex Head Driver:	
466006	3/16" Hex Head Driver
466008	1/4" Hex Head Driver
466010	5/16" Hex Head Driver
466012	3/8" Hex Head Driver
466014	7/16" Hex Head Driver
466018	9/16" Hex Head Driver
466022	11/16" Hex Head Driver
466024	3/4" Hex Head Driver

Metal Box

1200 g CODE : 005330
20 Sets / 25 Kgs / 0.88 CUFT

TH-408M (TH-408S)



3/4"Dr. Hex Head Drivers

Metric Hex Head Drivers

ITEM NO.	A	D	Length	Weight	PCS	G.W.	CUFT	CODE
	mm	mm	mm	g		KGS		@
648819	19	44	88	680	30	21.5	0.52	001940
648821	21	44	88	690	30	22.0	0.52	001940
648822	22	44	88	700	30	22.0	0.52	001940
648824	24	44	88	720	30	23.0	0.52	002070
648827	27	44	88	750	30	23.5	0.52	002070
648830	30	44	88	770	30	24.5	0.52	002200
648832	32	44	88	800	30	25.0	0.52	002200

SAE Hex Head Drivers

ITEM NO.	A	D	Length	Weight	PCS	G.W.	CUFT	CODE
	Inch	mm	mm	g		KGS		@
668824	3/4	44	88	680	30	21.5	0.52	002050
668826	13/16	44	88	690	30	22.0	0.52	002050
668828	7/8	44	88	700	30	22.0	0.52	002050
668830	15/16	44	88	720	30	23.0	0.52	002310
668832	1	44	88	740	30	23.5	0.52	002310
668834	1-1/16	44	88	750	30	23.5	0.52	002310
668836	1-1/8	44	88	760	30	24.0	0.52	002470
668838	1-3/16	44	88	770	30	24.5	0.52	002470
668840	1-1/4	44	88	800	30	25.0	0.52	002470

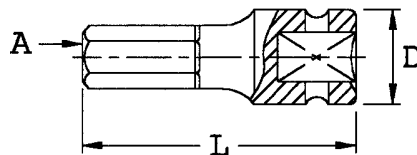



Slotted Bit Sockets

ITEM NO.	Size mm	Length mm	Weight g	PCS 	G.W. KGS	CUFT 	CODE @
208 + 1130	0.5X3.0	45	20	600	13.0	0.38	000235
208 + 1140	0.6X4.0	45	20	600	13.0	0.38	000235
208 + 1150	0.8X5.0	45	20	600	13.0	0.38	000235
208 + 1160	1.0X6.0	45	20	600	13.0	0.38	000235
208 + 1330	0.5X3.0	70	25	480	13.0	0.30	000300
208 + 1340	0.6X4.0	70	25	480	13.0	0.30	000300
208 + 1350	0.8X5.0	70	25	480	13.0	0.30	000300
208 + 1360	1.0X6.0	70	30	480	15.5	0.30	000300
208 + 1530	0.5X3.0	100	35	360	14.0	0.30	000440
208 + 1540	0.6X4.0	100	35	360	14.0	0.30	000440
208 + 1550	0.8X5.0	100	35	360	14.0	0.30	000440
208 + 1560	1.0X6.0	100	35	360	14.0	0.30	000440
208 + 1630	0.5X3.0	140	45	150	8.0	0.52	000480
208 + 1640	0.6X4.0	140	45	150	8.0	0.52	000480
208 + 1650	0.8X5.0	140	45	150	8.0	0.52	000480
208 + 1660	1.0X6.0	140	45	150	8.0	0.52	000480

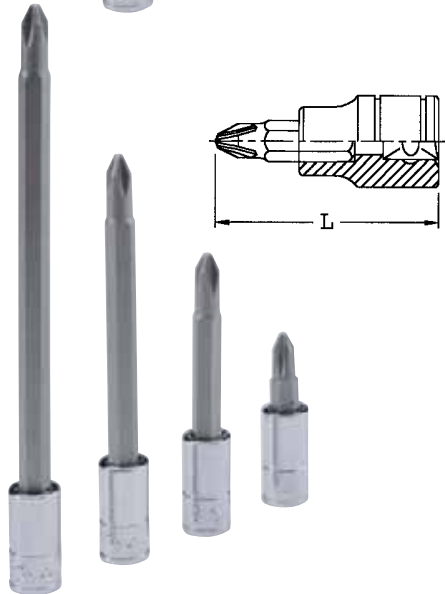

Philips Bit Sockets

ITEM NO.	Size	Length mm	Weight g	PCS 	G.W. KGS	CUFT 	CODE @
208 + 1100	#0	45	20	600	13.0	0.38	000235
208 + 1101	#1	45	20	600	13.0	0.38	000235
208 + 1102	#2	45	20	600	13.0	0.38	000235
208 + 1103	#3	45	20	600	13.0	0.38	000235
208 + 1301	#1	70	25	480	13.0	0.30	000300
208 + 1302	#2	70	30	480	15.5	0.30	000300
208 + 1303	#3	70	30	480	15.5	0.30	000300
208 + 1501	#1	100	35	360	14.0	0.30	000440
208 + 1502	#2	100	35	360	14.0	0.30	000440
208 + 1503	#3	100	35	360	14.0	0.30	000440
208 + 1601	#1	140	45	150	8.0	0.52	000480
208 + 1602	#2	140	45	150	8.0	0.52	000480
208 + 1603	#3	140	45	150	8.0	0.52	000480



BS-207L

BS-207S 7 Piece Slotted & Philips Bit Socket Set

Item No.	Description
1/4" Dr. Slotted Bit Socket 45mmL:	
208 + 1130	0.5 x 3.0 Slotted Bit Socket
208 + 1140	0.6 x 4.0 Slotted Bit Socket
208 + 1150	0.8 x 5.0 Slotted Bit Socket
208 + 1160	1.0 x 6.0 Slotted Bit Socket
1/4" Dr. Philips Bit Socket 45mmL:	
208 + 1101	#1 Philips Bit Socket
208 + 1102	#2 Philips Bit Socket
208 + 1103	#3 Philips Bit Socket
Socket Holder	

240 g CODE : 001480
 36 Sets / 10 Kgs / 0.73 CUFT

BS-207L 7 Piece Slotted & Philips Bit Socket Set

Item No.	Description
1/4" Dr. Slotted Bit Socket 100mmL:	
208 + 1530	0.5 x 3.0 Slotted Bit Socket
208 + 1540	0.6 x 4.0 Slotted Bit Socket
208 + 1550	0.8 x 5.0 Slotted Bit Socket
208 + 1560	1.0 x 6.0 Slotted Bit Socket
1/4" Dr. Philips Bit Socket 100mmL:	
208 + 1501	#1 Philips Bit Socket
208 + 1502	#2 Philips Bit Socket
208 + 1503	#3 Philips Bit Socket
Socket Holder	

345 g CODE : 002770
 20 Sets / 8 Kgs / 0.82 CUFT



BS-207S

TX-2353 53 Piece 1/4" & 3/8" Dr. Complete Bit Socket Set

Item No.	Description	Item No.	Description	Item No.	Description
1/4" Dr. Metric Hex Bit Socket 45mmL:		308 + 3116	1/4" Hex Bit Socket	1/4" Dr. Slotted Bit Socket 45mmL:	
208 + 2122	2mm Hex Bit Socket	310 + 3128	9/32" Hex Bit Socket	208 + 1130	0.5X3.0 Slotted Bit Socket
208 + 2125	2.5mm Hex Bit Socket	310 + 3130	5/16" Hex Bit Socket	208 + 1140	0.6X4.0 Slotted Bit Socket
208 + 2133	3mm Hex Bit Socket	312 + 3134	3/8" Hex Bit Socket	3/8" Dr. Slotted Bit Socket 50mmL:	
208 + 2134	4mm Hex Bit Socket	314 + 3138	7/16" Hex Bit Socket	308 + 1150	0.8X5.0 Slotted Bit Socket
1/4" Dr. SAE Hex Bit Socket 45mmL:		316 + 3142	1/2" Hex Bit Socket	308 + 1160	1.0X6.0 Slotted Bit Socket
208 + 3104	1/16" Hex Bit Socket	1/4" Dr. Star Bit Socket 45mmL:		310 + 1280	1.2X8.0 Slotted Bit Socket
208 + 3105	5/64" Hex Bit Socket	208 + 6106	T-6 Star Bit Socket	1/4" Dr. Philips Bit Socket 45mmL:	
208 + 3106	3/32" Hex Bit Socket	208 + 6107	T-7 Star Bit Socket	208 + 1101	#1 Philips Bit Socket
208 + 3107	7/64" Hex Bit Socket	208 + 6108	T-8 Star Bit Socket	208 + 1102	#2 Philips Bit Socket
208 + 3108	1/8" Hex Bit Socket	208 + 6109	T-9 Star Bit Socket	3/8" Dr. Philips Bit Socket 50mmL:	
208 + 3110	5/32" Hex Bit Socket	208 + 6110	T-10 Star Bit Socket	308 + 1103	#3 Philips Bit Socket
3/8" Dr. Metric Hex Bit Socket 50mmL:		208 + 6115	T-15 Star Bit Socket	310 + 1124	#4 Philips Bit Socket
308 + 2135	5mm Hex Bit Socket	3/8" Dr. Star Bit Socket 50mmL:		3/8" Dr. Triple Square Bit Socket 50mmL:	
308 + 2136	6mm Hex Bit Socket	308 + 6120	T-20 Star Bit Socket	308 + 8104	M4 Triple Square Bit Socket
310 + 2147	7mm Hex Bit Socket	308 + 6125	T-25 Star Bit Socket	308 + 8105	M5 Triple Square Bit Socket
310 + 2148	8mm Hex Bit Socket	308 + 6127	T-27 Star Bit Socket	308 + 8106	M6 Triple Square Bit Socket
340 + 2150	10mm Hex Bit Socket	308 + 6130	T-30 Star Bit Socket	310 + 8108	M8 Triple Square Bit Socket
342 + 2152	12mm Hex Bit Socket	308 + 6140	T-40 Star Bit Socket	340 + 8110	M10 Triple Square Bit Socket
3/8" Dr. SAE Hex Bit Socket 50mmL:		310 + 6245	T-45 Star Bit Socket	342 + 8112	M12 Triple Square Bit Socket
308 + 3112	3/16" Hex Bit Socket	310 + 6250	T-50 Star Bit Socket	Plastic Tray	
308 + 3114	7/32" Hex Bit Socket	340 + 6255	T-55 Star Bit Socket		

2500 g 5 Sets / 13.5 Kgs / 0.93 CUFT CODE : 013580

BS-214PL 14 Piece Slotted & Philips Bit Socket Set

Item No.	Description
1/4" Dr. Slotted Bit Socket 45mmL:	
208 + 1130	0.5 x 3.0 Slotted Bit Socket
208 + 1140	0.6 x 4.0 Slotted Bit Socket
208 + 1150	0.8 x 5.0 Slotted Bit Socket
208 + 1160	1.0 x 6.0 Slotted Bit Socket
1/4" Dr. Philips Bit Socket 45mmL:	
208 + 1101	#1 Philips Bit Socket
208 + 1102	#2 Philips Bit Socket
208 + 1103	#3 Philips Bit Socket
1/4" Dr. Slotted Bit Socket 140mmL:	
208 + 1630	0.5 x 3.0 Slotted Bit Socket
208 + 1640	0.6 x 4.0 Slotted Bit Socket
208 + 1650	0.8 x 5.0 Slotted Bit Socket
208 + 1660	1.0 x 6.0 Slotted Bit Socket
1/4" Dr. Philips Bit Socket 140mmL:	
208 + 1601	#1 Philips Bit Socket
208 + 1602	#2 Philips Bit Socket
208 + 1603	#3 Philips Bit Socket

650 g CODE : 004500
8 Sets / 6 Kgs / 0.88 CUFT



TX-2353

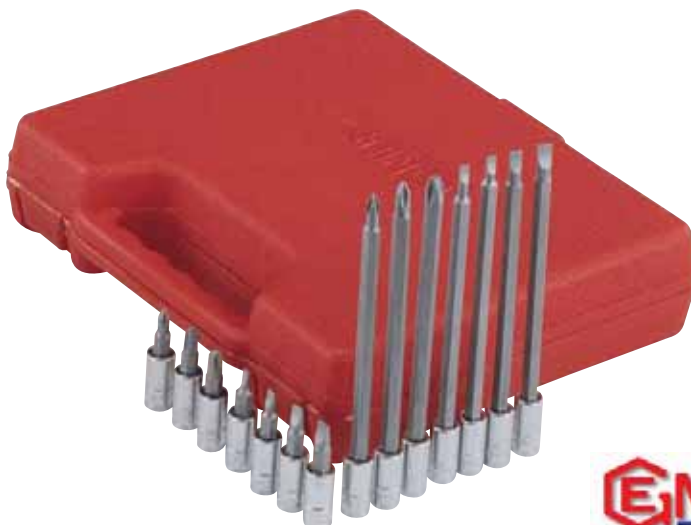

BS-214PL





Metric Hex Bit Sockets

ITEM NO.	Size mm	Length mm	Weight g	PCS 	G.W. KGS	CUFT 	CODE @
208+2122	2	45	20	600	13.0	0.38	000235
208+2125	2.5	45	20	600	13.0	0.38	000235
208+2133	3	45	20	600	13.0	0.38	000235
208+2134	4	45	20	600	13.0	0.38	000235
208+2135	5	45	20	600	13.0	0.38	000235
208+2136	6	45	20	600	13.0	0.38	000235
208+2322	2	70	25	480	13.0	0.30	000300
208+2325	2.5	70	25	480	13.0	0.30	000300
208+2333	3	70	30	480	15.5	0.30	000300
208+2334	4	70	30	480	15.5	0.30	000300
208+2335	5	70	30	480	15.5	0.30	000300
208+2336	6	70	30	480	15.5	0.30	000300
208+2522	2	100	35	360	14.0	0.30	000440
208+2525	2.5	100	35	360	14.0	0.30	000440
208+2533	3	100	35	360	14.0	0.30	000440
208+2534	4	100	35	360	14.0	0.30	000440
208+2535	5	100	35	360	14.0	0.30	000440
208+2536	6	100	40	360	15.5	0.30	000440
208+2622	2	140	45	150	8.0	0.52	000480
208+2625	2.5	140	45	150	8.0	0.52	000480
208+2633	3	140	45	150	8.0	0.52	000480
208+2634	4	140	45	150	8.0	0.52	000480
208+2635	5	140	45	150	8.0	0.52	000480
208+2636	6	140	45	150	8.0	0.52	000480



SAE Hex Bit Sockets

ITEM NO.	Size Inch	Length mm	Weight g	PCS 	G.W. KGS	CUFT 	CODE @
208+3104	1/16	45	20	600	13.0	0.38	000235
208+3105	5/64	45	20	600	13.0	0.38	000235
208+3106	3/32	45	20	600	13.0	0.38	000235
208+3107	7/64	45	20	600	13.0	0.38	000235
208+3108	1/8	45	20	600	13.0	0.38	000235
208+3110	5/32	45	20	600	13.0	0.38	000235
208+3112	3/16	45	20	600	13.0	0.38	000235
208+3114	7/32	45	20	600	13.0	0.38	000235
208+3116	1/4	45	25	600	16.0	0.38	000235
208+3304	1/16	70	25	480	13.0	0.30	000300
208+3305	5/64	70	25	480	13.0	0.30	000300
208+3306	3/32	70	25	480	13.0	0.30	000300
208+3307	7/64	70	25	480	13.0	0.30	000300
208+3308	1/8	70	30	480	15.5	0.30	000300
208+3310	5/32	70	30	480	15.5	0.30	000300
208+3312	3/16	70	30	480	15.5	0.30	000300
208+3314	7/32	70	30	480	15.5	0.30	000300
208+3316	1/4	70	30	480	15.5	0.30	000300
208+3504	1/16	100	35	360	14.0	0.30	000440
208+3505	5/64	100	35	360	14.0	0.30	000440
208+3506	3/32	100	35	360	14.0	0.30	000440
208+3507	7/64	100	35	360	14.0	0.30	000440
208+3508	1/8	100	35	360	14.0	0.30	000440
208+3510	5/32	100	35	360	14.0	0.30	000440
208+3512	3/16	100	35	360	14.0	0.30	000440
208+3514	7/32	100	40	360	15.5	0.30	000440
208+3516	1/4	100	40	360	15.5	0.30	000440

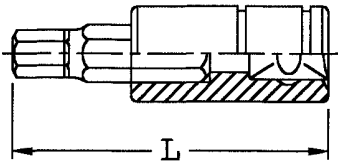

SAE Hex Bit Sockets

ITEM NO.	Size Inch	Length mm	Weight g	PCS 	G.W. KGS	CUFT 	CODE @
208 + 3604	1/16	140	45	150	8.0	0.52	000480
208 + 3605	5/64	140	45	150	8.0	0.52	000480
208 + 3606	3/32	140	45	150	8.0	0.52	000480
208 + 3607	7/64	140	45	150	8.0	0.52	000480
208 + 3608	1/8	140	45	150	8.0	0.52	000480
208 + 3610	5/32	140	45	150	8.0	0.52	000480
208 + 3612	3/16	140	45	150	8.0	0.52	000480
208 + 3614	7/32	140	45	150	8.0	0.52	000480
208 + 3616	1/4	140	45	150	8.0	0.52	000480



BS-2324HL 24 Piece Metric Hex Bit Socket Set

Item No.	Description
1/4" Dr. Metric Hex Bit Socket 45mmL:	
208 + 2122	2mm Hex Bit Socket
208 + 2125	2.5mm Hex Bit Socket
208 + 2133	3mm Hex Bit Socket
208 + 2134	4mm Hex Bit Socket
208 + 2135	5mm Hex Bit Socket
208 + 2136	6mm Hex Bit Socket
3/8" Dr. Metric Hex Bit Socket 50mmL:	
310 + 2147	7mm Hex Bit Socket
310 + 2148	8mm Hex Bit Socket
339 + 2149	9mm Hex Bit Socket
340 + 2150	10mm Hex Bit Socket
341 + 2151	11mm Hex Bit Socket
342 + 2152	12mm Hex Bit Socket
1/4" Dr. Metric Hex Bit Socket 140mmL:	
208 + 2622	2mm Hex Bit Socket
208 + 2625	2.5mm Hex Bit Socket
208 + 2633	3mm Hex Bit Socket
208 + 2634	4mm Hex Bit Socket
208 + 2635	5mm Hex Bit Socket
208 + 2636	6mm Hex Bit Socket
3/8" Dr. Metric Hex Bit Socket 140mmL:	
310 + 2647	7mm Hex Bit Socket
310 + 2648	8mm Hex Bit Socket
339 + 2649	9mm Hex Bit Socket
340 + 2650	10mm Hex Bit Socket
341 + 2651	11mm Hex Bit Socket
342 + 2652	12mm Hex Bit Socket

1710 g CODE : 010500
 12 Sets / 21.5 Kgs / 1.16 CUFT

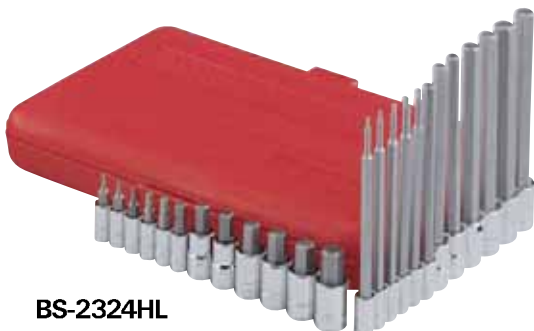

BS-2324HL

BS-2312H 12 Piece Metric Hex Bit Socket Set

Item No.	Description
1/4" Dr. Metric Hex Bit Socket 45mmL:	
208 + 2122	2mm Hex Bit Socket
208 + 2125	2.5mm Hex Bit Socket
208 + 2133	3mm Hex Bit Socket
208 + 2134	4mm Hex Bit Socket
208 + 2135	5mm Hex Bit Socket
208 + 2136	6mm Hex Bit Socket
3/8" Dr. Metric Hex Bit Socket 50mmL:	
310 + 2147	7mm Hex Bit Socket
310 + 2148	8mm Hex Bit Socket
339 + 2149	9mm Hex Bit Socket
340 + 2150	10mm Hex Bit Socket
341 + 2151	11mm Hex Bit Socket
342 + 2152	12mm Hex Bit Socket

595 g CODE : 003440
 36 Sets / 22.5 Kgs / 0.73 CUFT



BS-2312H

BS-2312HL 12 Piece Metric Hex Bit Socket Set

Item No.	Description
1/4" Dr. Metric Hex Bit Socket 100mmL:	
208 + 2522	2mm Hex Bit Socket
208 + 2525	2.5mm Hex Bit Socket
208 + 2533	3mm Hex Bit Socket
208 + 2534	4mm Hex Bit Socket
208 + 2535	5mm Hex Bit Socket
208 + 2536	6mm Hex Bit Socket
3/8" Dr. Metric Hex Bit Socket 110mmL:	
310 + 2547	7mm Hex Bit Socket
310 + 2548	8mm Hex Bit Socket
339 + 2549	9mm Hex Bit Socket
340 + 2550	10mm Hex Bit Socket
341 + 2551	11mm Hex Bit Socket
342 + 2552	12mm Hex Bit Socket

895 g CODE : 005990
 20 Sets / 19 Kgs / 0.82 CUFT



BS-2312HL



Hex Bit Socket Sets

BS-2314H 14 Piece SAE Hex Bit Socket Set

Item No.	Description
1/4" Dr. SAE Hex Bit Socket 45mmL:	
208+3104	1/16" Hex Bit Socket
208+3105	5/64" Hex Bit Socket
208+3106	3/32" Hex Bit Socket
208+3107	7/64" Hex Bit Socket
208+3108	1/8" Hex Bit Socket
208+3110	5/32" Hex Bit Socket
208+3112	3/16" Hex Bit Socket
208+3114	7/32" Hex Bit Socket
208+3116	1/4" Hex Bit Socket
3/8" Dr. SAE Hex Bit Socket 50mmL:	
310+3128	9/32" Hex Bit Socket
310+3130	5/16" Hex Bit Socket
312+3134	3/8" Hex Bit Socket
314+3138	7/16" Hex Bit Socket
316+3142	1/2" Hex Bit Socket

Socket Holder

615 g CODE : 003740

36 Sets / 23.5 Kgs / 0.73 CUFT

BS-2314H



BS-2328HL

BS-2328HL 28 Piece SAE Hex Bit Socket Set

Item No.	Description
1/4" Dr. SAE Hex Bit Socket 45mmL:	
208+3104	1/16" Hex Bit Socket
208+3105	5/64" Hex Bit Socket
208+3106	3/32" Hex Bit Socket
208+3107	7/64" Hex Bit Socket
208+3108	1/8" Hex Bit Socket
208+3110	5/32" Hex Bit Socket
208+3112	3/16" Hex Bit Socket
208+3114	7/32" Hex Bit Socket
208+3116	1/4" Hex Bit Socket
3/8" Dr. SAE Hex Bit Socket 50mmL:	
310+3128	9/32" Hex Bit Socket
310+3130	5/16" Hex Bit Socket
312+3134	3/8" Hex Bit Socket
314+3138	7/16" Hex Bit Socket
316+3142	1/2" Hex Bit Socket

Socket Holder

1790 g CODE : 011520

6 Sets / 12 Kgs / 1.21 CUFT



BS-2314HL



BS-2314HL 14 Piece SAE Hex Bit Socket Set



Item No.	Description
1/4" Dr. SAE Hex Bit Socket 100mmL:	
208+3504	1/16" Hex Bit Socket
208+3505	5/64" Hex Bit Socket
208+3506	3/32" Hex Bit Socket
208+3507	7/64" Hex Bit Socket
208+3508	1/8" Hex Bit Socket
208+3510	5/32" Hex Bit Socket
208+3512	3/16" Hex Bit Socket
208+3514	7/32" Hex Bit Socket
208+3516	1/4" Hex Bit Socket
3/8" Dr. SAE Hex Bit Socket 110mmL:	
310+3518	9/32" Hex Bit Socket
310+3520	5/16" Hex Bit Socket
312+3524	3/8" Hex Bit Socket
314+3528	7/16" Hex Bit Socket
316+3532	1/2" Hex Bit Socket

Socket Holder

945 g CODE : 006700



20 Sets / 20 Kgs / 0.82 CUFT

Metric Wobble Hex Bit Sockets

ITEM NO.	Size mm	Length mm	Weight g	PCS 	G.W. KGS	CUFT 	CODE @
208+4133	3	45	20	600	13.0	0.38	000265
208+4134	4	45	20	600	13.0	0.38	000265
208+4135	5	45	20	600	13.0	0.38	000265
208+4136	6	45	20	600	13.0	0.38	000265
208+4333	3	70	30	480	15.5	0.30	000330
208+4334	4	70	30	480	15.5	0.30	000330
208+4335	5	70	30	480	15.5	0.30	000330
208+4336	6	70	30	480	15.5	0.30	000330
208+4533	3	100	35	360	14.0	0.30	000480
208+4534	4	100	35	360	14.0	0.30	000480
208+4535	5	100	35	360	14.0	0.30	000480
208+4536	6	100	35	360	14.0	0.30	000480
208+4633	3	140	45	150	8.0	0.52	000530
208+4634	4	140	45	150	8.0	0.52	000530
208+4635	5	140	45	150	8.0	0.52	000530
208+4636	6	140	45	150	8.0	0.52	000530



SAE Wobble Hex Bit Sockets

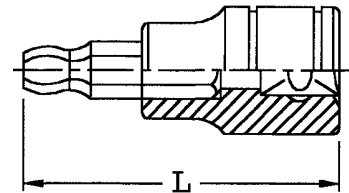

ITEM NO.	Size Inch	Length mm	Weight g	PCS 	G.W. KGS	CUFT 	CODE @
208+5108	1/8	45	20	600	13.0	0.38	000265
208+5110	5/32	45	20	600	13.0	0.38	000265
208+5112	3/16	45	20	600	13.0	0.38	000265
208+5114	7/32	45	20	600	13.0	0.38	000265
208+5116	1/4	45	20	600	13.0	0.38	000265
208+5308	1/8	70	30	480	15.5	0.30	000330
208+5310	5/32	70	30	480	15.5	0.30	000330
208+5312	3/16	70	30	480	15.5	0.30	000330
208+5314	7/32	70	30	480	15.5	0.30	000330
208+5316	1/4	70	30	480	15.5	0.30	000330
208+5508	1/8	100	35	360	14.0	0.30	000480
208+5510	5/32	100	35	360	14.0	0.30	000480
208+5512	3/16	100	35	360	14.0	0.30	000480
208+5514	7/32	100	35	360	14.0	0.30	000480
208+5516	1/4	100	40	360	15.5	0.30	000480
208+5608	1/8	140	45	150	8.0	0.52	000530
208+5610	5/32	140	45	150	8.0	0.52	000530
208+5612	3/16	140	45	150	8.0	0.52	000530
208+5614	7/32	140	45	150	8.0	0.52	000530
208+5616	1/4	140	45	150	8.0	0.52	000530



BS-2316WH

BS-2316WH 16 Piece Metric Wobble Hex Bit Socket Set

Item No.	Description	Item No.	Description
1/4" Dr. Metric Wobble Hex Bit Socket 45mmL:		1/4" Dr. Metric Wobble Hex Bit Socket 140mmL:	
208+4133	3mm Wobble Hex Bit Socket	208+4633	3mm Wobble Hex Bit Socket
208+4134	4mm Wobble Hex Bit Socket	208+4634	4mm Wobble Hex Bit Socket
208+4135	5mm Wobble Hex Bit Socket	208+4635	5mm Wobble Hex Bit Socket
208+4136	6mm Wobble Hex Bit Socket	208+4636	6mm Wobble Hex Bit Socket
3/8" Dr. Metric Wobble Hex Bit Socket 50mmL:		3/8" Dr. Metric Wobble Hex Bit Socket 140mmL:	
310+4147	7mm Wobble Hex Bit Socket	310+4647	7mm Wobble Hex Bit Socket
310+4148	8mm Wobble Hex Bit Socket	310+4648	8mm Wobble Hex Bit Socket
339+4149	9mm Wobble Hex Bit Socket	339+4649	9mm Wobble Hex Bit Socket
340+4150	10mm Wobble Hex Bit Socket	340+4650	10mm Wobble Hex Bit Socket
			Blow Case

 1100 g  8 Sets / 10 Kgs / 0.88 CUFT CODE : 007190



Wobble Hex Bit Socket Sets

BS-2308WR 8 Piece Metric Wobble Hex Bit Socket Set

Item No.	Description
1/4" Dr. Metric Wobble Hex Bit Socket 45mmL:	
208+4133	3mm Wobble Hex Bit Socket
208+4134	4mm Wobble Hex Bit Socket
208+4135	5mm Wobble Hex Bit Socket
208+4136	6mm Wobble Hex Bit Socket
3/8" Dr. Metric Wobble Hex Bit Socket 50mmL:	
310+4147	7mm Wobble Hex Bit Socket
310+4148	8mm Wobble Hex Bit Socket
339+4149	9mm Wobble Hex Bit Socket
340+4150	10mm Wobble Hex Bit Socket
Socket Holder	

400 g CODE : 002400

20 Sets / 9.0 Kgs / 0.82 CUFT

BS-2308WR



BS-2308WH 8 Piece Metric Wobble Hex Bit Socket Set

Item No.	Description
1/4" Dr. Metric Wobble Hex Bit Socket 70mmL:	
208+4333	3mm Wobble Hex Bit Socket
208+4334	4mm Wobble Hex Bit Socket
208+4335	5mm Wobble Hex Bit Socket
208+4336	6mm Wobble Hex Bit Socket
3/8" Dr. Metric Wobble Hex Bit Socket 110mmL:	
310+4547	7mm Wobble Hex Bit Socket
310+4548	8mm Wobble Hex Bit Socket
339+4549	9mm Wobble Hex Bit Socket
340+4550	10mm Wobble Hex Bit Socket
Socket Holder	

555 g CODE : 003490

20 Sets / 12.5 Kgs / 0.82 CUFT

BS-2308WH



BS-2316WS 16 Piece SAE Wobble Hex Bit Socket Set

Item No.	Description
1/4" Dr. SAE Wobble Hex Bit Socket 45mmL:	
208+5108	1/8" Wobble Hex Bit Socket
208+5110	5/32" Wobble Hex Bit Socket
208+5112	3/16" Wobble Hex Bit Socket
208+5114	7/32" Wobble Hex Bit Socket
208+5116	1/4" Wobble Hex Bit Socket
3/8" Dr. SAE Wobble Hex Bit Socket 50mmL:	
310+5118	9/32" Wobble Hex Bit Socket
310+5120	5/16" Wobble Hex Bit Socket
312+5124	3/8" Wobble Hex Bit Socket
1/4" Dr. SAE Wobble Hex Bit Socket 140mmL:	
208+5608	1/8" Wobble Hex Bit Socket
208+5610	5/32" Wobble Hex Bit Socket
208+5612	3/16" Wobble Hex Bit Socket
208+5614	7/32" Wobble Hex Bit Socket
208+5616	1/4" Wobble Hex Bit Socket
3/8" Dr. SAE Wobble Hex Bit Socket 140mmL:	
310+5618	9/32" Wobble Hex Bit Socket
310+5620	5/16" Wobble Hex Bit Socket
312+5624	3/8" Wobble Hex Bit Socket
Blow Case	

800 g CODE : 006670

8 Sets / 7.5 Kgs / 0.88 CUFT

BS-2316WS



BS-2308SW



BS-2308SW 8 Piece SAE Wobble Hex Bit Socket Set

Item No.	Description
1/4" Dr. SAE Wobble Hex Bit Socket 70mmL:	
208+5308	1/8" Wobble Hex Bit Socket
208+5310	5/32" Wobble Hex Bit Socket
208+5312	3/16" Wobble Hex Bit Socket
208+5314	7/32" Wobble Hex Bit Socket
208+5316	1/4" Wobble Hex Bit Socket
3/8" Dr. SAE Wobble Hex Bit Socket 110mmL:	
310+5518	9/32" Wobble Hex Bit Socket
310+5520	5/16" Wobble Hex Bit Socket
312+5524	3/8" Wobble Hex Bit Socket
Socket Holder	

490 g CODE : 003150

20 Sets / 11 Kgs / 0.82 CUFT

BS-2308SR





BS-2308SR 8 Piece SAE Wobble Hex Bit Socket Set

Item No.	Description
1/4" Dr. SAE Wobble Hex Bit Socket 45mmL:	
208+5108	1/8" Wobble Hex Bit Socket
208+5110	5/32" Wobble Hex Bit Socket
208+5112	3/16" Wobble Hex Bit Socket
208+5114	7/32" Wobble Hex Bit Socket
208+5116	1/4" Wobble Hex Bit Socket
3/8" Dr. SAE Wobble Hex Bit Socket 50mmL:	
310+5118	9/32" Wobble Hex Bit Socket
310+5120	5/16" Wobble Hex Bit Socket
312+5124	3/8" Wobble Hex Bit Socket
Socket Holder	

365 g CODE : 002240

20 Sets / 8.5 Kgs / 0.82 CUFT

Star Bit Sockets

ITEM NO.	Size	Length mm	Weight g	PCS 	G.W. KGS	CUFT 	CODE @
208 + 6106	T-6	45	20	600	13.0	0.38	000235
208 + 6107	T-7	45	20	600	13.0	0.38	000235
208 + 6108	T-8	45	20	600	13.0	0.38	000235
208 + 6109	T-9	45	20	600	13.0	0.38	000235
208 + 6110	T-10	45	20	600	13.0	0.38	000235
208 + 6115	T-15	45	20	600	13.0	0.38	000235
208 + 6120	T-20	45	20	600	13.0	0.38	000235
208 + 6125	T-25	45	20	600	13.0	0.38	000235
208 + 6127	T-27	45	20	600	13.0	0.38	000235
208 + 6130	T-30	45	20	600	13.0	0.38	000235
208 + 6140	T-40	45	25	600	16.0	0.38	000235
208 + 6306	T-6	70	25	480	13.0	0.30	000300
208 + 6307	T-7	70	25	480	13.0	0.30	000300
208 + 6308	T-8	70	25	480	13.0	0.30	000300
208 + 6309	T-9	70	25	480	13.0	0.30	000300
208 + 6310	T-10	70	25	480	13.0	0.30	000300
208 + 6315	T-15	70	30	480	15.5	0.30	000300
208 + 6320	T-20	70	30	480	15.5	0.30	000300
208 + 6325	T-25	70	30	480	15.5	0.30	000300
208 + 6327	T-27	70	30	480	15.5	0.30	000300
208 + 6330	T-30	70	30	480	15.5	0.30	000300
208 + 6340	T-40	70	30	480	15.5	0.30	000300
208 + 6506	T-6	100	35	360	14.0	0.30	000440
208 + 6507	T-7	100	35	360	14.0	0.30	000440
208 + 6508	T-8	100	35	360	14.0	0.30	000440
208 + 6509	T-9	100	35	360	14.0	0.30	000440
208 + 6510	T-10	100	35	360	14.0	0.30	000440
208 + 6515	T-15	100	35	360	14.0	0.30	000440
208 + 6520	T-20	100	35	360	14.0	0.30	000440
208 + 6525	T-25	100	35	360	14.0	0.30	000440
208 + 6527	T-27	100	35	360	14.0	0.30	000440
208 + 6530	T-30	100	35	360	14.0	0.30	000440
208 + 6540	T-40	100	40	360	15.5	0.30	000440
208 + 6606	T-6	140	45	150	8.0	0.52	000480
208 + 6607	T-7	140	45	150	8.0	0.52	000480
208 + 6608	T-8	140	45	150	8.0	0.52	000480
208 + 6609	T-9	140	45	150	8.0	0.52	000480
208 + 6610	T-10	140	45	150	8.0	0.52	000480
208 + 6615	T-15	140	45	150	8.0	0.52	000480
208 + 6620	T-20	140	45	150	8.0	0.52	000480
208 + 6625	T-25	140	45	150	8.0	0.52	000480
208 + 6627	T-27	140	45	150	8.0	0.52	000480
208 + 6630	T-30	140	45	150	8.0	0.52	000480
208 + 6640	T-40	140	45	150	8.0	0.52	000480

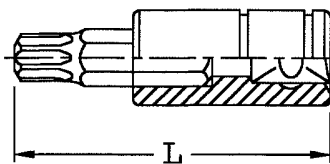



Star Bit Socket Sets

BS-2314T 14 Piece Star Bit Socket Set

Item No.	Description
1/4" Dr. Star Bit Socket 45mmL:	
208 + 6106	T-6 Star Bit Socket
208 + 6107	T-7 Star Bit Socket
208 + 6108	T-8 Star Bit Socket
208 + 6109	T-9 Star Bit Socket
208 + 6110	T-10 Star Bit Socket
208 + 6115	T-15 Star Bit Socket
208 + 6120	T-20 Star Bit Socket
208 + 6125	T-25 Star Bit Socket
208 + 6127	T-27 Star Bit Socket
208 + 6130	T-30 Star Bit Socket
208 + 6140	T-40 Star Bit Socket
3/8" Dr. Star Bit Socket 50mmL:	
310 + 6245	T-45 Star Bit Socket
310 + 6250	T-50 Star Bit Socket
340 + 6255	T-55 Star Bit Socket
Socket Holder	

485 g CODE : 003290
 36 Sets / 18.5 Kgs / 0.73 CUFT

BS-2314T



BS-2314TL



BS-2328TL

BS-2314TL 14 Piece Star Bit Socket Set

Item No.	Description
1/4" Dr. Star Bit Socket 100mmL:	
208 + 6506	T-6 Star Bit Socket
208 + 6507	T-7 Star Bit Socket
208 + 6508	T-8 Star Bit Socket
208 + 6509	T-9 Star Bit Socket
208 + 6510	T-10 Star Bit Socket
208 + 6515	T-15 Star Bit Socket
208 + 6520	T-20 Star Bit Socket
208 + 6525	T-25 Star Bit Socket
208 + 6527	T-27 Star Bit Socket
208 + 6530	T-30 Star Bit Socket
208 + 6540	T-40 Star Bit Socket
3/8" Dr. Star Bit Socket 110mmL:	
310 + 6545	T-45 Star Bit Socket
310 + 6550	T-50 Star Bit Socket
340 + 6555	T-55 Star Bit Socket
Socket Holder	

730 g CODE : 005920
 20 Sets / 16 Kgs / 0.83 CUFT

BS-2328TL 28 Piece Star Bit Socket Set

Item No.	Description
1/4" Dr. Star Bit Socket 45mmL:	
208 + 6106	T-6 Star Bit Socket
208 + 6107	T-7 Star Bit Socket
208 + 6108	T-8 Star Bit Socket
208 + 6109	T-9 Star Bit Socket
208 + 6110	T-10 Star Bit Socket
208 + 6115	T-15 Star Bit Socket
208 + 6120	T-20 Star Bit Socket
208 + 6125	T-25 Star Bit Socket
208 + 6127	T-27 Star Bit Socket
208 + 6130	T-30 Star Bit Socket
208 + 6140	T-40 Star Bit Socket
3/8" Dr. Star Bit Socket 50mmL:	
310 + 6245	T-45 Star Bit Socket
310 + 6250	T-50 Star Bit Socket
340 + 6255	T-55 Star Bit Socket
1/4" Dr. Star Bit Socket 140mmL:	
208 + 6606	T-6 Star Bit Socket
208 + 6607	T-7 Star Bit Socket
208 + 6608	T-8 Star Bit Socket
208 + 6609	T-9 Star Bit Socket
208 + 6610	T-10 Star Bit Socket
208 + 6615	T-15 Star Bit Socket
208 + 6620	T-20 Star Bit Socket
208 + 6625	T-25 Star Bit Socket
208 + 6627	T-27 Star Bit Socket
208 + 6630	T-30 Star Bit Socket
208 + 6640	T-40 Star Bit Socket
3/8" Dr. Star Bit Socket 140mmL:	
310 + 6645	T-45 Star Bit Socket
310 + 6650	T-50 Star Bit Socket
340 + 6655	T-55 Star Bit Socket
Blow Case	

1590 g CODE : 009950
 6 Sets / 10.5 Kgs / 1.21 CUFT

Tamperproof Star Bit Sockets

ITEM NO.	Size	Length mm	Weight g	PCS 	G.W. KGS	CUFT 	CODE @
208 + 7107	T-7	45	20	600	13.0	0.38	000265
208 + 7108	T-8	45	20	600	13.0	0.38	000265
208 + 7109	T-9	45	20	600	13.0	0.38	000265
208 + 7110	T-10	45	20	600	13.0	0.38	000265
208 + 7115	T-15	45	20	600	13.0	0.38	000265
208 + 7120	T-20	45	20	600	13.0	0.38	000265
208 + 7125	T-25	45	20	600	13.0	0.38	000265
208 + 7127	T-27	45	20	600	13.0	0.38	000265
208 + 7130	T-30	45	20	600	13.0	0.38	000265
208 + 7140	T-40	45	25	600	16.0	0.38	000265
208 + 7307	T-7	70	25	480	13.0	0.30	000330
208 + 7308	T-8	70	25	480	13.0	0.30	000330
208 + 7309	T-9	70	25	480	13.0	0.30	000330
208 + 7310	T-10	70	25	480	13.0	0.30	000330
208 + 7315	T-15	70	30	480	15.5	0.30	000330
208 + 7320	T-20	70	30	480	15.5	0.30	000330
208 + 7325	T-25	70	30	480	15.5	0.30	000330
208 + 7327	T-27	70	30	480	15.5	0.30	000330
208 + 7330	T-30	70	30	480	15.5	0.30	000330
208 + 7340	T-40	70	30	480	15.5	0.30	000330
208 + 7507	T-7	100	35	360	14.0	0.30	000480
208 + 7508	T-8	100	35	360	14.0	0.30	000480
208 + 7509	T-9	100	35	360	14.0	0.30	000480
208 + 7510	T-10	100	35	360	14.0	0.30	000480
208 + 7515	T-15	100	35	360	14.0	0.30	000480
208 + 7520	T-20	100	35	360	14.0	0.30	000480
208 + 7525	T-25	100	35	360	14.0	0.30	000480
208 + 7527	T-27	100	35	360	14.0	0.30	000480
208 + 7530	T-30	100	35	360	14.0	0.30	000480
208 + 7540	T-40	100	40	360	15.5	0.30	000480
208 + 7607	T-7	140	45	150	8.0	0.52	000530
208 + 7608	T-8	140	45	150	8.0	0.52	000530
208 + 7609	T-9	140	45	150	8.0	0.52	000530
208 + 7610	T-10	140	45	150	8.0	0.52	000530
208 + 7615	T-15	140	45	150	8.0	0.52	000530
208 + 7620	T-20	140	45	150	8.0	0.52	000530
208 + 7625	T-25	140	45	150	8.0	0.52	000530
208 + 7627	T-27	140	45	150	8.0	0.52	000530
208 + 7630	T-30	140	45	150	8.0	0.52	000530
208 + 7640	T-40	140	45	150	8.0	0.52	000530

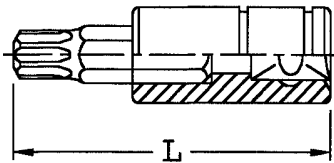



Star Bit Socket Sets

BS-2313TP 13 Piece Tamperproof Star Bit Socket Set

Item No.	Description
1/4" Dr. Tamperproof Star Bit Socket 45mmL:	
208 + 7107	T-7 Tamperproof Star Bit Socket
208 + 7108	T-8 Tamperproof Star Bit Socket
208 + 7109	T-9 Tamperproof Star Bit Socket
208 + 7110	T-10 Tamperproof Star Bit Socket
208 + 7115	T-15 Tamperproof Star Bit Socket
208 + 7120	T-20 Tamperproof Star Bit Socket
208 + 7125	T-25 Tamperproof Star Bit Socket
208 + 7127	T-27 Tamperproof Star Bit Socket
208 + 7130	T-30 Tamperproof Star Bit Socket
208 + 7140	T-40 Tamperproof Star Bit Socket
3/8" Dr. Tamperproof Star Bit Socket 45mmL:	
310 + 7145	T-45 Tamperproof Star Bit Socket
310 + 7150	T-50 Tamperproof Star Bit Socket
340 + 7155	T-55 Tamperproof Star Bit Socket
Socket Holder	

465 g CODE : 003430
 20 Sets / 10.5 Kgs / 0.82 CUFT

BS-2313TA 13 Piece Tamperproof Star Bit Socket Set

Item No.	Description
1/4" Dr. Tamperproof Star Bit Socket 70mmL:	
208 + 7307	T-7 Tamperproof Star Bit Socket
208 + 7308	T-8 Tamperproof Star Bit Socket
208 + 7309	T-9 Tamperproof Star Bit Socket
208 + 7310	T-10 Tamperproof Star Bit Socket
208 + 7315	T-15 Tamperproof Star Bit Socket
208 + 7320	T-20 Tamperproof Star Bit Socket
208 + 7325	T-25 Tamperproof Star Bit Socket
208 + 7327	T-27 Tamperproof Star Bit Socket
208 + 7330	T-30 Tamperproof Star Bit Socket
208 + 7340	T-40 Tamperproof Star Bit Socket
3/8" Dr. Tamperproof Star Bit Socket 110mmL:	
310 + 7545	T-45 Tamperproof Star Bit Socket
310 + 7550	T-50 Tamperproof Star Bit Socket
340 + 7555	T-55 Tamperproof Star Bit Socket
Socket Holder	

620 g CODE : 004630
 20 Sets / 13.5 Kgs / 0.82 CUFT

BS-2313TP

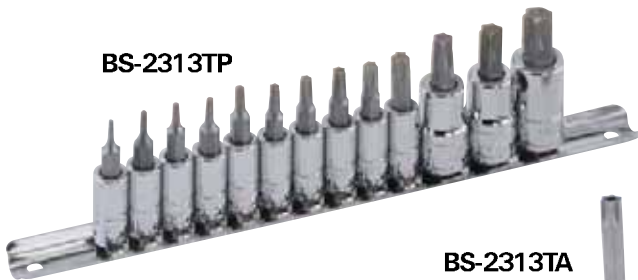

BS-2313TA



BS-2326TAL 26 Piece Tamperproof Star Bit Socket Set

Item No.	Description
1/4" Dr. Tamperproof Star Bit Socket 45mmL:	
208 + 7107	T-7 Tamperproof Star Bit Socket
208 + 7108	T-8 Tamperproof Star Bit Socket
208 + 7109	T-9 Tamperproof Star Bit Socket
208 + 7110	T-10 Tamperproof Star Bit Socket
208 + 7115	T-15 Tamperproof Star Bit Socket
208 + 7120	T-20 Tamperproof Star Bit Socket
208 + 7125	T-25 Tamperproof Star Bit Socket
208 + 7127	T-27 Tamperproof Star Bit Socket
208 + 7130	T-30 Tamperproof Star Bit Socket
208 + 7140	T-40 Tamperproof Star Bit Socket
3/8" Dr. Tamperproof Star Bit Socket 50mmL:	
310 + 7145	T-45 Tamperproof Star Bit Socket
310 + 7150	T-50 Tamperproof Star Bit Socket
340 + 7155	T-55 Tamperproof Star Bit Socket
1/4" Dr. Tamperproof Star Bit Socket 140mmL:	
208 + 7607	T-7 Tamperproof Star Bit Socket
208 + 7608	T-8 Tamperproof Star Bit Socket
208 + 7609	T-9 Tamperproof Star Bit Socket
208 + 7610	T-10 Tamperproof Star Bit Socket
208 + 7615	T-15 Tamperproof Star Bit Socket
208 + 7620	T-20 Tamperproof Star Bit Socket
208 + 7625	T-25 Tamperproof Star Bit Socket
208 + 7627	T-27 Tamperproof Star Bit Socket
208 + 7630	T-30 Tamperproof Star Bit Socket
208 + 7640	T-40 Tamperproof Star Bit Socket
3/8" Dr. Tamperproof Star Bit Socket 140mmL:	
310 + 7645	T-45 Tamperproof Star Bit Socket
310 + 7650	T-50 Tamperproof Star Bit Socket
340 + 7655	T-55 Tamperproof Star Bit Socket
Blow Case	

1530 g CODE : 010250
 6 Sets / 10 Kgs / 1.21 CUFT





BS-2326TAL

Triple Square Bit Sockets

1/4

Triple Square Bit Sockets

ITEM NO.	Size	Length mm	Weight g	PCS 	G.W. KGS	CUFT 	CODE @
208 + 8104	M4	45	20	600	13.0	0.38	000240
208 + 8105	M5	45	20	600	13.0	0.38	000240
208 + 8106	M6	45	20	600	13.0	0.38	000240
208 + 8304	M4	70	25	480	13.0	0.30	000300
208 + 8305	M5	70	30	480	15.5	0.30	000300
208 + 8306	M6	70	30	480	15.5	0.30	000300
208 + 8504	M4	100	35	360	14.0	0.30	000440
208 + 8505	M5	100	35	360	14.0	0.30	000440
208 + 8506	M6	100	35	360	14.0	0.30	000440
208 + 8604	M4	140	45	150	8.0	0.52	000480
208 + 8605	M5	140	45	150	8.0	0.52	000480
208 + 8606	M6	140	45	150	8.0	0.52	000480



BS-2314TR 14 Piece Triple Square Bit Socket Set

Item No.	Description
1/4" Dr. Triple Square Bit Socket 45mmL:	
208 + 8104	M4 Triple Square Bit Socket
208 + 8105	M5 Triple Square Bit Socket
208 + 8106	M6 Triple Square Bit Socket
3/8" Dr. Triple Square Bit Socket 50mmL:	
310 + 8108	M8 Triple Square Socket
340 + 8110	M10 Triple Square Socket
342 + 8112	M12 Triple Square Socket
344 + 8114	M14 Triple Square Socket
1/4" Dr. Triple Square Bit Socket 140mmL:	
208 + 8604	M4 Triple Square Bit Socket
208 + 8605	M5 Triple Square Bit Socket
208 + 8606	M6 Triple Square Bit Socket
3/8" Dr. Triple Square Bit Socket 140mmL:	
310 + 8608	M8 Triple Square Bit Socket
340 + 8610	M10 Triple Square Bit Socket
342 + 8612	M12 Triple Square Bit Socket
344 + 8614	M14 Triple Square Bit Socket

 1260 g CODE : 006810

 8 Sets / 11 Kgs / 0.88 CUFT

BS-2314TR



BS-2307TS 7 Piece Triple Square Bit Socket Set

Item No.	Description
1/4" Dr. Triple Square Bit Socket 45mmL:	
208 + 8104	M4 Triple Square Bit Socket
208 + 8105	M5 Triple Square Bit Socket
208 + 8106	M6 Triple Square Bit Socket
3/8" Dr. Triple Square Bit Socket 50mmL:	
310 + 8108	M8 Triple Square Socket
340 + 8110	M10 Triple Square Socket
342 + 8112	M12 Triple Square Socket
344 + 8114	M14 Triple Square Socket

 435 g CODE : 002200

 36 Sets / 17 Kgs / 0.73 CUFT

BS-2307TL 7 Piece Triple Square Bit Socket Set

Item No.	Description
1/4" Dr. Triple Square Bit Socket 100mmL:	
208 + 8504	M4 Triple Square Bit Socket
208 + 8505	M5 Triple Square Bit Socket
208 + 8506	M6 Triple Square Bit Socket
3/8" Dr. Triple Square Bit Socket 110mmL:	
310 + 8508	M8 Triple Square Socket
340 + 8510	M10 Triple Square Socket
342 + 8512	M12 Triple Square Socket
344 + 8514	M14 Triple Square Socket

 675 g CODE : 003850

 20 Sets / 14.5 Kgs / 0.82 CUFT

BS-2307TL



BS-2307TS

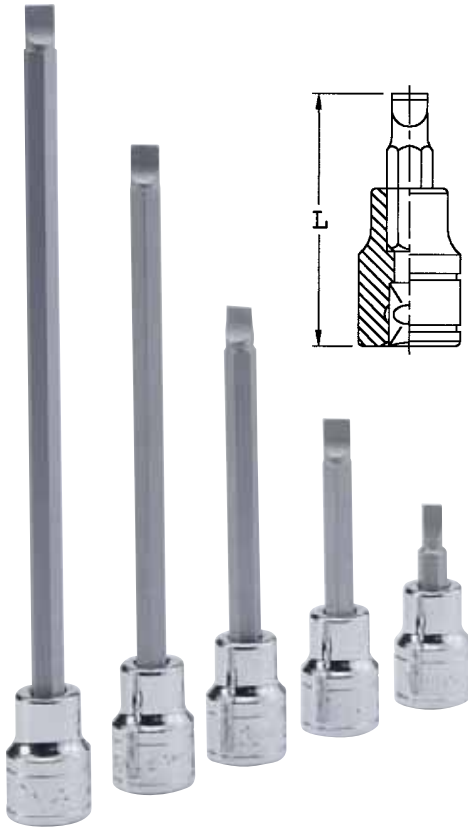

Slotted Bit Sockets

ITEM NO.	Size mm	Length mm	Weight g	PCS 	G.W. KGS	CUFT 	CODE @
308 + 1140	0.6X4.0	50	40	240	11.0	0.30	000285
308 + 1150	0.8X5.0	50	40	240	11.0	0.30	000285
308 + 1160	1.0X6.0	50	40	240	11.0	0.30	000285
310 + 1280	1.2X8.0	50	50	240	13.0	0.30	000325
310 + 1290	1.6X9.0	50	50	240	13.0	0.30	000325
308 + 1540	0.6X4.0	110	55	200	12.0	0.59	000490
308 + 1550	0.8X5.0	110	55	200	12.0	0.59	000490
308 + 1560	1.0X6.0	110	55	200	12.0	0.59	000490
310 + 1580	1.2X8.0	110	70	200	15.0	0.59	000530
310 + 1590	1.6X9.0	110	70	200	15.0	0.59	000530
308 + 1640	0.6X4.0	140	65	150	11.0	0.52	000530
308 + 1650	0.8X5.0	140	65	150	11.0	0.52	000530
308 + 1660	1.0X6.0	140	65	150	11.0	0.52	000530
310 + 1680	1.2X8.0	140	85	150	14.0	0.52	000630
310 + 1690	1.6X9.0	140	85	150	14.0	0.52	000630
308 + 1740	0.6X4.0	180	75	100	8.0	0.62	000610
308 + 1750	0.8X5.0	180	75	100	8.0	0.62	000610
308 + 1760	1.0X6.0	180	75	100	8.0	0.62	000610
310 + 1780	1.2X8.0	180	100	100	10.5	0.62	000730
310 + 1790	1.6X9.0	180	100	100	10.5	0.62	000730
308 + 1840	0.6X4.0	220	85	100	10.0	0.62	000680
308 + 1850	0.8X5.0	220	85	100	10.0	0.62	000680
308 + 1860	1.0X6.0	220	85	100	10.0	0.62	000680
310 + 1880	1.2X8.0	220	120	100	13.0	0.62	000830
310 + 1890	1.6X9.0	220	120	100	13.0	0.62	000830

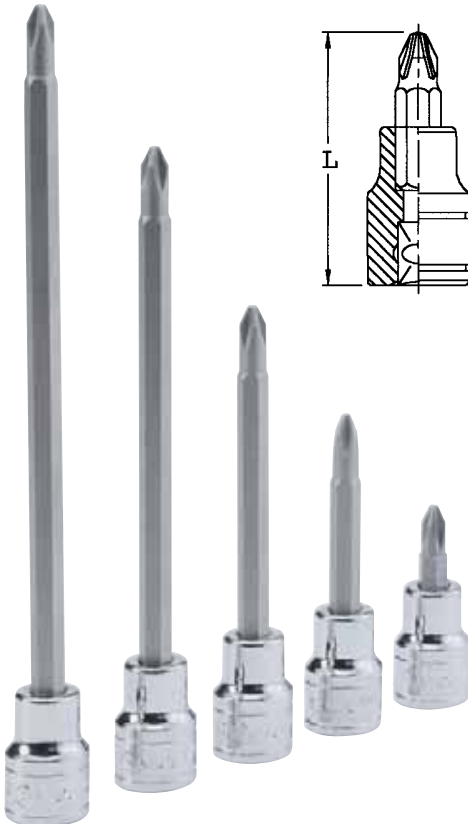

Philips Bit Sockets

ITEM NO.	Size	Length mm	Weight g	PCS 	G.W. KGS	CUFT 	CODE @
308 + 1101	#1	50	40	240	11.0	0.30	000285
308 + 1102	#2	50	40	240	11.0	0.30	000285
308 + 1103	#3	50	40	240	11.0	0.30	000285
310 + 1124	#4	50	45	240	12.0	0.30	000325
308 + 1501	#1	110	55	200	12.0	0.59	000490
308 + 1502	#2	110	55	200	12.0	0.59	000490
308 + 1503	#3	110	55	200	12.0	0.59	000490
310 + 1504	#4	110	70	200	15.0	0.59	000530
308 + 1601	#1	140	65	150	11.0	0.52	000530
308 + 1602	#2	140	65	150	11.0	0.52	000530
308 + 1603	#3	140	65	150	11.0	0.52	000530
310 + 1604	#4	140	85	150	14.0	0.52	000630
308 + 1701	#1	180	75	100	8.0	0.62	000610
308 + 1702	#2	180	75	100	8.0	0.62	000610
308 + 1703	#3	180	75	100	8.0	0.62	000610
310 + 1704	#4	180	100	100	10.5	0.62	000730
308 + 1801	#1	220	85	100	10.0	0.62	000680
308 + 1802	#2	220	85	100	10.0	0.62	000680
308 + 1803	#3	220	85	100	10.0	0.62	000680
310 + 1804	#4	220	120	100	13.0	0.62	000830

BS-309S 9 Piece Slotted & Philips Bit Sockets

Item No.	Description
3/8" Dr. Slotted Bit Socket 50mmL:	
308 + 1140	0.6 x 4.0 Slotted Bit Socket
308 + 1150	0.8 x 5.0 Slotted Bit Socket
308 + 1160	1.0 x 6.0 Slotted Bit Socket
310 + 1280	1.2 x 8.0 Slotted Bit Socket
310 + 1290	1.6 x 9.0 Slotted Bit Socket
3/8" Dr. Philips Bit Socket 50mmL:	
308 + 1101	#1 Philips Bit Socket
308 + 1102	#2 Philips Bit Socket
308 + 1103	#3 Philips Bit Socket
310 + 1124	#4 Philips Bit Socket
Socket Holder	

485 g CODE : 002410

36 Sets / 18.5 Kgs / 0.73 CUFT

BS-309L 9 Piece Slotted & Philips Bit Sockets

Item No.	Description
3/8" Dr. Slotted Bit Socket 110mmL:	
308 + 1540	0.6 x 4.0 Slotted Bit Socket
308 + 1550	0.8 x 5.0 Slotted Bit Socket
308 + 1560	1.0 x 6.0 Slotted Bit Socket
310 + 1580	1.2 x 8.0 Slotted Bit Socket
310 + 1590	1.6 x 9.0 Slotted Bit Socket
3/8" Dr. Philips Bit Socket 110mmL:	
308 + 1501	#1 Philips Bit Socket
308 + 1502	#2 Philips Bit Socket
308 + 1503	#3 Philips Bit Socket
310 + 1504	#4 Philips Bit Socket
Socket Holder	

640 g CODE : 004080

20 Sets / 14 Kgs / 0.82 CUFT

BS-318PL 18 Piece Slotted & Philips Bit Sockets

Item No.	Description
3/8" Dr. Slotted Bit Socket 50mmL:	
308 + 1140	0.6 x 4.0 Slotted Bit Socket
308 + 1150	0.8 x 5.0 Slotted Bit Socket
308 + 1160	1.0 x 6.0 Slotted Bit Socket
310 + 1280	1.2 x 8.0 Slotted Bit Socket
310 + 1290	1.6 x 9.0 Slotted Bit Socket
3/8" Dr. Philips Bit Socket 50mmL:	
308 + 1101	#1 Philips Bit Socket
308 + 1102	#2 Philips Bit Socket
308 + 1103	#3 Philips Bit Socket
310 + 1124	#4 Philips Bit Socket
3/8" Dr. Slotted Bit Socket 180mmL:	
308 + 1740	0.6 x 4.0 Slotted Bit Socket
308 + 1750	0.8 x 5.0 Slotted Bit Socket
308 + 1760	1.0 x 6.0 Slotted Bit Socket
310 + 1780	1.2 x 8.0 Slotted Bit Socket
310 + 1790	1.6 x 9.0 Slotted Bit Socket
3/8" Dr. Philips Bit Socket 180mmL:	
308 + 1701	#1 Philips Bit Socket
308 + 1702	#2 Philips Bit Socket
308 + 1703	#3 Philips Bit Socket
310 + 1704	#4 Philips Bit Socket

Blow Case

1460 g CODE : 007680

12 Sets / 18.5 Kgs / 1.16 CUFT

BS-309S



BS-309L



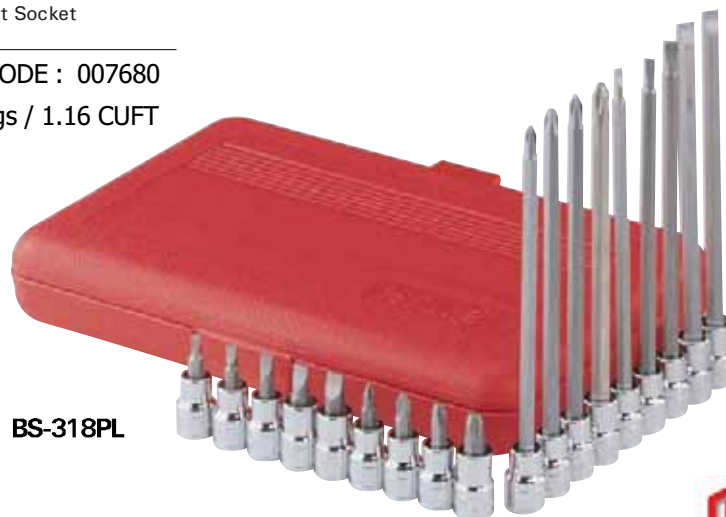

BS-318PL



Metric Hex Bit Sockets



ITEM NO.	Size mm	Length mm	Weight g	PCS 	G.W. KGS	CUFT 	CODE @
308+2133	3	50	40	240	10.0	0.30	000285
308+2134	4	50	40	240	10.5	0.30	000285
308+2135	5	50	40	240	10.5	0.30	000285
308+2136	6	50	40	240	10.5	0.30	000285
310+2147	7	50	45	240	12.5	0.30	000325
310+2148	8	50	50	240	12.5	0.30	000325
339+2149	9	50	60	240	15.5	0.30	000420
340+2150	10	50	65	240	17.5	0.30	000420
341+2151	11	50	75	240	19.0	0.30	000465
342+2152	12	50	80	240	20.0	0.30	000465

308+2533	3	110	55	200	12.0	0.59	000490
308+2534	4	110	55	200	12.0	0.59	000490
308+2535	5	110	55	200	12.0	0.59	000490
308+2536	6	110	55	200	12.0	0.59	000490
310+2547	7	110	70	200	15.0	0.59	000530
310+2548	8	110	70	200	15.5	0.59	000530
339+2549	9	110	90	200	19.0	0.59	000670
340+2550	10	110	100	200	22.0	0.59	000670
341+2551	11	110	120	200	25.0	0.59	000810
342+2552	12	110	130	200	27.5	0.59	000810

308+2633	3	140	65	150	10.5	0.52	000530
308+2634	4	140	65	150	10.5	0.52	000530
308+2635	5	140	65	150	11.0	0.52	000530
308+2636	6	140	65	150	11.0	0.52	000530
310+2647	7	140	85	150	14.0	0.52	000630
310+2648	8	140	90	150	14.0	0.52	000630
339+2649	9	140	115	150	18.5	0.52	000830
340+2650	10	140	130	150	20.5	0.52	000830
341+2651	11	140	155	150	24.5	0.52	001020
342+2652	12	140	170	150	26.5	0.52	001020

308+2733	3	180	75	100	8.0	0.62	000610
308+2734	4	180	75	100	8.0	0.62	000610
308+2735	5	180	75	100	8.0	0.62	000610
308+2736	6	180	75	100	8.0	0.62	000610
310+2747	7	180	100	100	10.5	0.62	000730
310+2748	8	180	100	100	10.5	0.62	000730
339+2749	9	180	135	100	14.0	0.62	000970
340+2750	10	180	150	100	15.5	0.62	000970
341+2751	11	180	180	100	18.5	0.62	001150
342+2752	12	180	200	100	20.5	0.62	001150

308+2836	6	220	85	100	9.5	0.62	000680
310+2847	7	220	120	100	13.0	0.62	000830
310+2848	8	220	120	100	13.0	0.62	000830
339+2849	9	220	160	100	17.0	0.62	001070
340+2850	10	220	180	100	19.0	0.62	001070
341+2851	11	220	220	100	23.0	0.62	001270
342+2852	12	220	250	100	26.0	0.62	001270

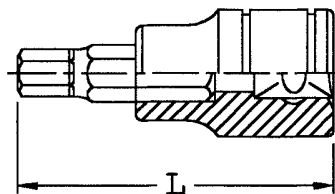

BS-2324HL 24 Piece Metric Hex Bit Socket Set

Item No.	Description
1/4" Dr. Metric Hex Bit Socket 45mmL:	
208 + 2122	2mm Hex Bit Socket
208 + 2125	2.5mm Hex Bit Socket
208 + 2133	3mm Hex Bit Socket
208 + 2134	4mm Hex Bit Socket
208 + 2135	5mm Hex Bit Socket
208 + 2136	6mm Hex Bit Socket
3/8" Dr. Metric Hex Bit Socket 50mmL:	
310 + 2147	7mm Hex Bit Socket
310 + 2148	8mm Hex Bit Socket
339 + 2149	9mm Hex Bit Socket
340 + 2150	10mm Hex Bit Socket
341 + 2151	11mm Hex Bit Socket
342 + 2152	12mm Hex Bit Socket
1/4" Dr. Metric Hex Bit Socket 140mmL:	
208 + 2622	2mm Hex Bit Socket
208 + 2625	2.5mm Hex Bit Socket
208 + 2633	3mm Hex Bit Socket
208 + 2634	4mm Hex Bit Socket
208 + 2635	5mm Hex Bit Socket
208 + 2636	6mm Hex Bit Socket
3/8" Dr. Metric Hex Bit Socket 140mmL:	
310 + 2647	7mm Hex Bit Socket
310 + 2648	8mm Hex Bit Socket
339 + 2649	9mm Hex Bit Socket
340 + 2650	10mm Hex Bit Socket
341 + 2651	11mm Hex Bit Socket
342 + 2652	12mm Hex Bit Socket

1710 g CODE : 010500
 12 Sets / 21.5 Kgs / 1.16 CUFT

BS-320HMX 20 Piece Metric Hex Bit Socket Set

Item No.	Description
3/8" Dr. Metric Hex Bit Socket 50mmL:	
308 + 2133	3mm Hex Bit Socket
308 + 2134	4mm Hex Bit Socket
308 + 2135	5mm Hex Bit Socket
308 + 2136	6mm Hex Bit Socket
310 + 2147	7mm Hex Bit Socket
310 + 2148	8mm Hex Bit Socket
339 + 2149	9mm Hex Bit Socket
340 + 2150	10mm Hex Bit Socket
341 + 2151	11mm Hex Bit Socket
342 + 2152	12mm Hex Bit Socket
3/8" Dr. Metric Hex Bit Socket 180mmL:	
308 + 2733	3mm Hex Bit Socket
308 + 2734	4mm Hex Bit Socket
308 + 2735	5mm Hex Bit Socket
308 + 2736	6mm Hex Bit Socket
310 + 2747	7mm Hex Bit Socket
310 + 2748	8mm Hex Bit Socket
339 + 2749	9mm Hex Bit Socket
340 + 2750	10mm Hex Bit Socket
341 + 2751	11mm Hex Bit Socket
342 + 2752	12mm Hex Bit Socket

2020 g CODE : 010500
 6 Sets / 13 Kgs / 1.21 CUFT

BS-310HM 10 Piece Metric Hex Bit Socket Set

Item No.	Description
3/8" Dr. Metric Hex Bit Socket 50mmL:	
308 + 2133	3mm Hex Bit Socket
308 + 2134	4mm Hex Bit Socket
308 + 2135	5mm Hex Bit Socket
308 + 2136	6mm Hex Bit Socket
310 + 2147	7mm Hex Bit Socket
310 + 2148	8mm Hex Bit Socket
339 + 2149	9mm Hex Bit Socket
340 + 2150	10mm Hex Bit Socket
341 + 2151	11mm Hex Bit Socket
342 + 2152	12mm Hex Bit Socket

635 g CODE : 003200
 36 Sets / 24 Kgs / 0.73 CUFT

BS-310HM



BS-310HML 10 Piece Metric Hex Bit Socket Set

Item No.	Description
3/8" Dr. Metric Hex Bit Socket 110mmL:	
308 + 2533	3mm Hex Bit Socket
308 + 2534	4mm Hex Bit Socket
308 + 2535	5mm Hex Bit Socket
308 + 2536	6mm Hex Bit Socket
310 + 2547	7mm Hex Bit Socket
310 + 2548	8mm Hex Bit Socket
339 + 2549	9mm Hex Bit Socket
340 + 2550	10mm Hex Bit Socket
341 + 2551	11mm Hex Bit Socket
342 + 2552	12mm Hex Bit Socket

900 g CODE : 005380
 20 Sets / 19 Kgs / 0.82 CUFT

BS-310HML



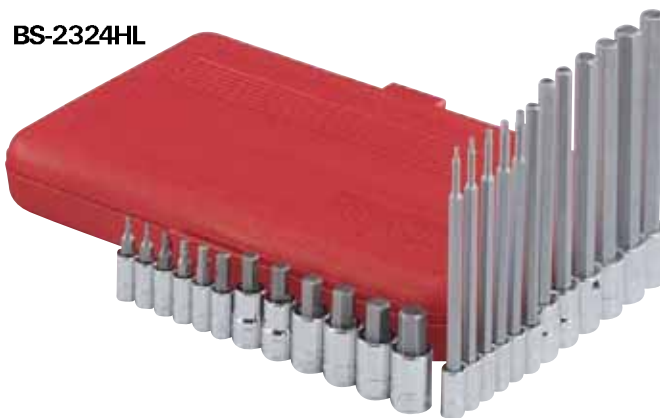

BS-2324HL



BS-320HMX

SAE Hex Bit Sockets



ITEM NO.	Size Inch	Length mm	Weight g	PCS 	G.W. KGS	CUFT 	CODE @
308+3108	1/8	50	40	240	11.0	0.30	000285
308+3110	5/32	50	40	240	11.0	0.30	000285
308+3112	3/16	50	40	240	11.0	0.30	000285
308+3114	7/32	50	40	240	11.0	0.30	000285
308+3116	1/4	50	40	240	11.0	0.30	000285
310+3128	9/32	50	45	240	12.0	0.30	000325
310+3130	5/16	50	50	240	13.0	0.30	000325
312+3134	3/8	50	65	240	17.0	0.30	000420
314+3138	7/16	50	75	240	19.0	0.30	000465
316+3142	1/2	50	95	240	24.0	0.30	000510
308+3508	1/8	110	55	200	12.0	0.59	000490
308+3510	5/32	110	55	200	12.0	0.59	000490
308+3512	3/16	110	55	200	12.0	0.59	000490
308+3514	7/32	110	55	200	12.0	0.59	000490
308+3516	1/4	110	55	200	12.0	0.59	000490
310+3518	9/32	110	70	200	15.0	0.59	000530
310+3520	5/16	110	70	200	15.0	0.59	000530
312+3524	3/8	110	100	200	21.0	0.59	000670
314+3528	7/16	110	120	160	21.0	0.44	000810
316+3532	1/2	110	160	160	27.0	0.44	000950
308+3608	1/8	140	65	150	11.0	0.52	000530
308+3610	5/32	140	65	150	11.0	0.52	000530
308+3612	3/16	140	65	150	11.0	0.52	000530
308+3614	7/32	140	65	150	11.0	0.52	000530
308+3616	1/4	140	65	150	11.0	0.52	000530
310+3618	9/32	140	85	150	14.0	0.52	000630
310+3620	5/16	140	90	150	15.0	0.52	000630
312+3624	3/8	140	130	150	20.5	0.52	000870
314+3628	7/16	140	160	150	25.0	0.52	001020
316+3632	1/2	140	200	100	21.0	0.34	001170
308+3708	1/8	180	75	100	8.0	0.62	000610
308+3710	5/32	180	75	100	8.0	0.62	000610
308+3712	3/16	180	75	100	8.0	0.62	000610
308+3714	7/32	180	75	100	8.0	0.62	000610
308+3716	1/4	180	75	100	8.0	0.62	000610
310+3718	9/32	180	100	100	10.5	0.62	000730
310+3720	5/16	180	100	100	10.5	0.62	000730
312+3724	3/8	180	145	100	15.0	0.62	000970
314+3728	7/16	180	180	100	18.5	0.62	001150
316+3732	1/2	180	220	80	18.0	0.44	001320
308+3816	1/4	220	85	100	10.0	0.62	000680
310+3818	9/32	220	120	100	13.0	0.62	000830
310+3820	5/16	220	120	100	13.0	0.62	000830
312+3824	3/8	220	170	100	18.0	0.62	001070
314+3828	7/16	220	220	100	23.0	0.62	001270
316+3832	1/2	220	280	80	24.0	0.44	001470

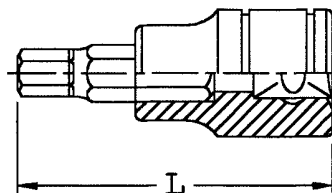

3/8

Wobble Hex Bit Sockets



Metric Wobble Hex Bit Sockets



ITEM NO.	Size mm	Length mm	Weight g	PCS 	G.W. KGS	CUFT 	CODE @
308+4133	3	50	40	240	11.0	0.30	000315
308+4134	4	50	40	240	11.0	0.30	000315
308+4135	5	50	40	240	11.0	0.30	000315
308+4136	6	50	40	240	11.0	0.30	000315
310+4147	7	50	45	240	12.0	0.30	000355
310+4148	8	50	50	240	13.0	0.30	000355
339+4149	9	50	60	240	15.5	0.30	000450
340+4150	10	50	65	240	17.0	0.30	000450
308+4533	3	110	55	200	12.0	0.59	000530
308+4534	4	110	55	200	12.0	0.59	000530
308+4535	5	110	55	200	12.0	0.59	000530
308+4536	6	110	55	200	12.0	0.59	000530
310+4547	7	110	70	200	15.0	0.59	000570
310+4548	8	110	75	200	15.5	0.59	000570
339+4549	9	110	90	200	19.0	0.59	000710
340+4550	10	110	100	200	21.0	0.59	000710
308+4633	3	140	65	150	11.0	0.52	000580
308+4634	4	140	65	150	11.0	0.52	000580
308+4635	5	140	65	150	11.0	0.52	000580
308+4636	6	140	65	150	11.0	0.52	000580
310+4647	7	140	85	150	14.0	0.52	000680
310+4648	8	140	90	150	14.5	0.52	000680
339+4649	9	140	115	150	18.5	0.52	000920
340+4650	10	140	130	150	20.5	0.52	000920
308+4733	3	180	75	100	8.0	0.62	000660
308+4734	4	180	75	100	8.0	0.62	000660
308+4735	5	180	75	100	8.0	0.62	000660
308+4736	6	180	75	100	8.0	0.62	000660
310+4747	7	180	100	100	10.5	0.62	000790
310+4748	8	180	100	100	10.5	0.62	000790
339+4749	9	180	135	100	14.0	0.62	001030
340+4750	10	180	150	100	15.5	0.62	001030
308+4836	6	220	85	100	9.5	0.62	000740
310+4847	7	220	120	100	13.0	0.62	000890
310+4848	8	220	120	100	13.0	0.62	000890
339+4849	9	220	160	100	17.0	0.62	001130
340+4850	10	220	180	100	19.0	0.62	001130

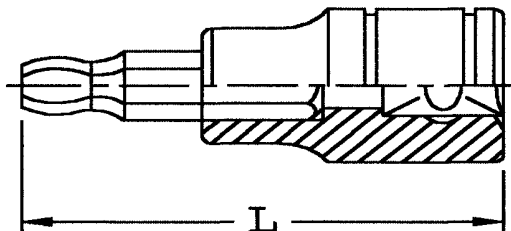

Wobble Hex Bit Socket Sets

3/8

BS-2316WH 16 Piece Metric Wobble Hex Bit Socket Set

Item No.	Description	Item No.	Description
1/4" Dr. Metric Wobble Hex Bit Socket 45mmL:			
208 + 4133	3mm Wobble Hex Bit Socket	1/4" Dr. Metric Wobble Hex Bit Socket 140mmL:	
208 + 4134	4mm Wobble Hex Bit Socket	208 + 4633	3mm Wobble Hex Bit Socket
208 + 4135	5mm Wobble Hex Bit Socket	208 + 4634	4mm Wobble Hex Bit Socket
208 + 4136	6mm Wobble Hex Bit Socket	208 + 4635	5mm Wobble Hex Bit Socket
3/8" Dr. Metric Wobble Hex Bit Socket 50mmL:			
310 + 4147	7mm Wobble Hex Bit Socket	208 + 4636	6mm Wobble Hex Bit Socket
310 + 4148	8mm Wobble Hex Bit Socket	3/8" Dr. Metric Wobble Hex Bit Socket 140mmL:	
339 + 4149	9mm Wobble Hex Bit Socket	310 + 4647	7mm Wobble Hex Bit Socket
340 + 4150	10mm Wobble Hex Bit Socket	310 + 4648	8mm Wobble Hex Bit Socket
		339 + 4649	9mm Wobble Hex Bit Socket
		340 + 4650	10mm Wobble Hex Bit Socket

1100 g 8 Sets / 10 Kgs / 0.88 CUFT CODE : 007190

BS-2316WH

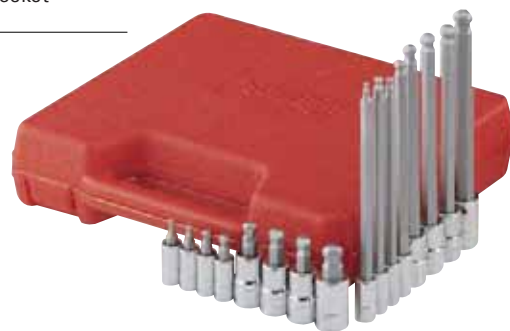

BS-316WHX 16 Piece Metric Wobble Hex Bit Socket Set

Item No.	Description
3/8" Dr. Metric Wobble Hex Bit Socket 50mmL:	
308 + 4133	3mm Wobble Hex Bit Socket
308 + 4134	4mm Wobble Hex Bit Socket
308 + 4135	5mm Wobble Hex Bit Socket
308 + 4136	6mm Wobble Hex Bit Socket
310 + 4147	7mm Wobble Hex Bit Socket
310 + 4148	8mm Wobble Hex Bit Socket
339 + 4149	9mm Wobble Hex Bit Socket
340 + 4150	10mm Wobble Hex Bit Socket
3/8" Dr. Metric Wobble Hex Bit Socket 180mmL:	
308 + 4733	3mm Wobble Hex Bit Socket
308 + 4734	4mm Wobble Hex Bit Socket
308 + 4735	5mm Wobble Hex Bit Socket
308 + 4736	6mm Wobble Hex Bit Socket
310 + 4747	7mm Wobble Hex Bit Socket
310 + 4748	8mm Wobble Hex Bit Socket
339 + 4749	9mm Wobble Hex Bit Socket
340 + 4750	10mm Wobble Hex Bit Socket

Blow Case

1700 g CODE : 008230

12 Sets / 21.5 Kgs / 1.16 CUFT

BS-316WHX



BS-308WH

BS-308WH 8 Piece Metric Wobble Hex Bit Socket Set

Item No.	Description
3/8" Dr. Metric Wobble Hex Bit Socket 50mmL:	
308 + 4133	3mm Wobble Hex Bit Socket
308 + 4134	4mm Wobble Hex Bit Socket
308 + 4135	5mm Wobble Hex Bit Socket
308 + 4136	6mm Wobble Hex Bit Socket
310 + 4147	7mm Wobble Hex Bit Socket
310 + 4148	8mm Wobble Hex Bit Socket
339 + 4149	9mm Wobble Hex Bit Socket
340 + 4150	10mm Wobble Hex Bit Socket

480 g CODE : 002590

36 Sets / 19 Kgs / 0.73 CUFT

BS-308WHL 8 Piece Metric Wobble Hex Bit Socket Set

Item No.	Description
3/8" Dr. Metric Wobble Hex Bit Socket 140mmL:	
308 + 4633	3mm Wobble Hex Bit Socket
308 + 4634	4mm Wobble Hex Bit Socket
308 + 4635	5mm Wobble Hex Bit Socket
308 + 4636	6mm Wobble Hex Bit Socket
310 + 4647	7mm Wobble Hex Bit Socket
310 + 4648	8mm Wobble Hex Bit Socket
339 + 4649	9mm Wobble Hex Bit Socket
340 + 4650	10mm Wobble Hex Bit Socket

780 g CODE : 004970

20 Sets / 17 Kgs / 0.82 CUFT

BS-308WHL



3/8

Wobble Hex Bit Sockets



SAE Wobble Hex Bit Sockets

ITEM NO.	Size Inch	Length mm	Weight g	PCS 	G.W. KGS	CUFT 	CODE @
308+5108	1/8	50	40	240	11.0	0.30	000315
308+5110	5/32	50	40	240	11.0	0.30	000315
308+5112	3/16	50	40	240	11.0	0.30	000315
308+5114	7/32	50	40	240	11.0	0.30	000315
308+5116	1/4	50	40	240	11.0	0.30	000315
310+5118	9/32	50	50	240	13.0	0.30	000355
310+5120	5/16	50	50	240	13.0	0.30	000355
312+5124	3/8	50	65	240	17.0	0.30	000450
308+5508	1/8	110	55	200	12.0	0.59	000530
308+5510	5/32	110	55	200	12.0	0.59	000530
308+5512	3/16	110	55	200	12.0	0.59	000530
308+5514	7/32	110	55	200	12.0	0.59	000530
308+5516	1/4	110	55	200	12.0	0.59	000530
310+5518	9/32	110	70	200	15.0	0.59	000570
310+5520	5/16	110	70	200	15.0	0.59	000570
312+5524	3/8	110	100	200	21.0	0.59	000710
308+5608	1/8	140	65	150	11.0	0.52	000580
308+5610	5/32	140	65	150	11.0	0.52	000580
308+5612	3/16	140	65	150	11.0	0.52	000580
308+5614	7/32	140	65	150	11.0	0.52	000580
308+5616	1/4	140	65	150	11.0	0.52	000580
310+5618	9/32	140	85	150	14.0	0.52	000680
310+5620	5/16	140	90	150	14.5	0.52	000680
312+5624	3/8	140	130	150	20.5	0.52	000920
308+5708	1/8	180	75	100	8.0	0.62	000660
308+5710	5/32	180	75	100	8.0	0.62	000660
308+5712	3/16	180	75	100	8.0	0.62	000660
308+5714	7/32	180	75	100	8.0	0.62	000660
308+5716	1/4	180	75	100	8.0	0.62	000660
310+5718	9/32	180	100	100	10.5	0.62	000790
310+5720	5/16	180	100	100	10.5	0.62	000790
312+5724	3/8	180	145	100	15.0	0.62	001030
308+5816	1/4	220	85	100	10.0	0.62	000740
310+5818	9/32	220	120	100	13.0	0.62	000890
310+5820	5/16	220	120	100	13.0	0.62	000890
312+5824	3/8	220	170	100	18.0	0.62	001130

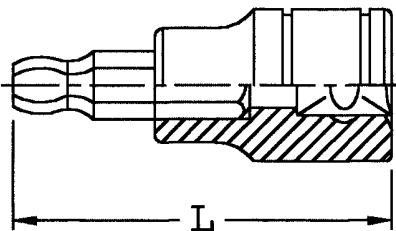

Wobble Hex Bit Socket Sets

3/8

BS-2316WS 16 Piece SAE Wobble Hex Bit Socket Set

Item No.	Description
1/4" Dr. SAE Wobble Hex Bit Socket 45mmL:	
208 + 5108	1/8" Wobble Hex Bit Socket
208 + 5110	5/32" Wobble Hex Bit Socket
208 + 5112	3/16" Wobble Hex Bit Socket
208 + 5114	7/32" Wobble Hex Bit Socket
208 + 5116	1/4" Wobble Hex Bit Socket
3/8" Dr. SAE Wobble Hex Bit Socket 50mmL:	
310 + 5118	9/32" Wobble Hex Bit Socket
310 + 5120	5/16" Wobble Hex Bit Socket
312 + 5124	3/8" Wobble Hex Bit Socket
1/4" Dr. SAE Wobble Hex Bit Socket 140mmL:	
208 + 5608	1/8" Wobble Hex Bit Socket
208 + 5610	5/32" Wobble Hex Bit Socket
208 + 5612	3/16" Wobble Hex Bit Socket
208 + 5614	7/32" Wobble Hex Bit Socket
208 + 5616	1/4" Wobble Hex Bit Socket
3/8" Dr. SAE Wobble Hex Bit Socket 140mmL:	
310 + 5618	9/32" Wobble Hex Bit Socket
310 + 5620	5/16" Wobble Hex Bit Socket
312 + 5624	3/8" Wobble Hex Bit Socket

Blow Case

 800 g CODE : 006670

 8 Sets / 7.5 Kgs / 0.88 CUFT

BS-316WSX 16 Piece SAE Wobble Hex Bit Socket Set

Item No.	Description
3/8" Dr. SAE Wobble Hex Bit Socket 50mmL:	
308 + 5108	1/8" Wobble Hex Bit Socket
308 + 5110	5/32" Wobble Hex Bit Socket
308 + 5112	3/16" Wobble Hex Bit Socket
308 + 5114	7/32" Wobble Hex Bit Socket
308 + 5116	1/4" Wobble Hex Bit Socket
310 + 5118	9/32" Wobble Hex Bit Socket
310 + 5120	5/16" Wobble Hex Bit Socket
312 + 5124	3/8" Wobble Hex Bit Socket
3/8" Dr. SAE Wobble Hex Bit Socket 180mmL:	
308 + 5708	1/8" Wobble Hex Bit Socket
308 + 5710	5/32" Wobble Hex Bit Socket
308 + 5712	3/16" Wobble Hex Bit Socket
308 + 5714	7/32" Wobble Hex Bit Socket
308 + 5716	1/4" Wobble Hex Bit Socket
310 + 5718	9/32" Wobble Hex Bit Socket
310 + 5720	5/16" Wobble Hex Bit Socket
312 + 5724	3/8" Wobble Hex Bit Socket

Blow Case

 1650 g CODE : 007780

 12 Sets / 21 Kgs / 1.16 CUFT

BS-308WHS 8 Piece SAE Wobble Hex Bit Socket Set

Item No.	Description
3/8" Dr. SAE Wobble Hex Bit Socket 50mmL:	
308 + 5108	1/8" Wobble Hex Bit Socket
308 + 5110	5/32" Wobble Hex Bit Socket
308 + 5112	3/16" Wobble Hex Bit Socket
308 + 5114	7/32" Wobble Hex Bit Socket
308 + 5116	1/4" Wobble Hex Bit Socket
310 + 5118	9/32" Wobble Hex Bit Socket
310 + 5120	5/16" Wobble Hex Bit Socket
312 + 5124	3/8" Wobble Hex Bit Socket

Socket Holder

 470 g CODE : 002460

 36 Sets / 18 Kgs / 0.73 CUFT

BS-308WSL 8 Piece SAE Wobble Hex Bit Socket Set

Item No.	Description
3/8" Dr. SAE Wobble Hex Bit Socket 110mmL:	
308 + 5508	1/8" Wobble Hex Bit Socket
308 + 5510	5/32" Wobble Hex Bit Socket
308 + 5512	3/16" Wobble Hex Bit Socket
308 + 5514	7/32" Wobble Hex Bit Socket
308 + 5516	1/4" Wobble Hex Bit Socket
310 + 5518	9/32" Wobble Hex Bit Socket
310 + 5520	5/16" Wobble Hex Bit Socket
312 + 5524	3/8" Wobble Hex Bit Socket

Socket Holder

 620 g CODE : 004050

 20 Sets / 13.5 Kgs / 0.82 CUFT

BS-2316WS



BS-316WSX

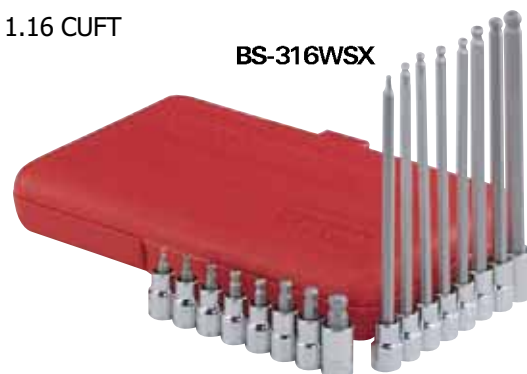

BS-308WHS



BS-308WSL





3/8

Star Bit Sockets

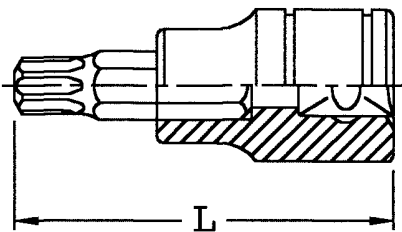
★ Star Bit Sockets



ITEM NO.	Size	Length mm	Weight g	PCS 	G.W. KGS	CUFT 	CODE @
308+6110	T-10	50	40	240	11.0	0.30	000285
308+6115	T-15	50	40	240	11.0	0.30	000285
308+6120	T-20	50	40	240	11.0	0.30	000285
308+6125	T-25	50	40	240	11.0	0.30	000285
308+6127	T-27	50	40	240	11.0	0.30	000285
308+6130	T-30	50	40	240	11.0	0.30	000285
308+6140	T-40	50	40	240	11.0	0.30	000285
310+6245	T-45	50	45	240	12.0	0.30	000325
310+6250	T-50	50	50	240	13.0	0.30	000325
340+6255	T-55	50	65	240	17.0	0.30	000420

308+6510	T-10	110	55	200	12.0	0.59	000490
308+6515	T-15	110	55	200	12.0	0.59	000490
308+6520	T-20	110	55	200	12.0	0.59	000490
308+6525	T-25	110	55	200	12.0	0.59	000490
308+6527	T-27	110	55	200	12.0	0.59	000490
308+6530	T-30	110	55	200	12.0	0.59	000490
308+6540	T-40	110	55	200	12.0	0.59	000490
310+6545	T-45	110	70	200	15.0	0.59	000530
310+6550	T-50	110	70	200	15.0	0.59	000530
340+6555	T-55	110	100	200	22.0	0.59	000670

308+6610	T-10	140	65	150	11.0	0.52	000530
308+6615	T-15	140	65	150	11.0	0.52	000530
308+6620	T-20	140	65	150	11.0	0.52	000530
308+6625	T-25	140	65	150	11.0	0.52	000530
308+6627	T-27	140	65	150	11.0	0.52	000530
308+6630	T-30	140	65	150	11.0	0.52	000530
308+6640	T-40	140	65	150	11.0	0.52	000530
310+6645	T-45	140	90	150	14.5	0.52	000630
310+6650	T-50	140	90	150	14.5	0.52	000630
340+6655	T-55	140	130	150	20.5	0.52	000870

308+6710	T-10	180	75	100	8.0	0.62	000610
308+6715	T-15	180	75	100	8.0	0.62	000610
308+6720	T-20	180	75	100	8.0	0.62	000610
308+6725	T-25	180	75	100	8.0	0.62	000610
308+6727	T-27	180	75	100	8.0	0.62	000610
308+6730	T-30	180	75	100	8.0	0.62	000610
308+6740	T-40	180	75	100	8.0	0.62	000610
310+6745	T-45	180	100	100	10.5	0.62	000730
310+6750	T-50	180	100	100	10.5	0.62	000730
340+6755	T-55	180	150	100	15.5	0.62	000970

308+6810	T-10	220	85	100	10.0	0.62	000680
308+6815	T-15	220	85	100	10.0	0.62	000680
308+6820	T-20	220	85	100	10.0	0.62	000680
308+6825	T-25	220	85	100	10.0	0.62	000680
308+6827	T-27	220	85	100	10.0	0.62	000680
308+6830	T-30	220	85	100	10.0	0.62	000680
308+6840	T-40	220	85	100	10.0	0.62	000680
310+6845	T-45	220	120	100	13.0	0.62	000830
310+6850	T-50	220	120	100	13.0	0.62	000830
340+6855	T-55	220	180	100	19.0	0.62	001070

BS-2328TL 28 Piece Star Bit Socket Set

Item No.	Description
1/4" Dr. Star Bit Socket 45mmL:	
208+6106	T-6 Star Bit Socket
208+6107	T-7 Star Bit Socket
208+6108	T-8 Star Bit Socket
208+6109	T-9 Star Bit Socket
208+6110	T-10 Star Bit Socket
208+6115	T-15 Star Bit Socket
208+6120	T-20 Star Bit Socket
208+6125	T-25 Star Bit Socket
208+6127	T-27 Star Bit Socket
208+6130	T-30 Star Bit Socket
208+6140	T-40 Star Bit Socket
3/8" Dr. Star Bit Socket 50mmL:	
310+6245	T-45 Star Bit Socket
310+6250	T-50 Star Bit Socket
340+6255	T-55 Star Bit Socket
1/4" Dr. Star Bit Socket 140mmL:	
208+6606	T-6 Star Bit Socket
208+6607	T-7 Star Bit Socket
208+6608	T-8 Star Bit Socket
208+6609	T-9 Star Bit Socket
208+6610	T-10 Star Bit Socket
208+6615	T-15 Star Bit Socket
208+6620	T-20 Star Bit Socket
208+6625	T-25 Star Bit Socket
208+6627	T-27 Star Bit Socket
208+6630	T-30 Star Bit Socket
208+6640	T-40 Star Bit Socket
3/8" Dr. Star Bit Socket 140mmL:	
310+6645	T-45 Star Bit Socket
310+6650	T-50 Star Bit Socket
340+6655	T-55 Star Bit Socket

1590 g CODE : 009950
6 Sets / 10.5 Kgs / 1.21 CUFT



BS-2328TL

BS-310T 10 Piece Star Bit Socket Set

Item No.	Description
3/8" Dr. Star Bit Socket 50mmL:	
308+6110	T-10 Star Bit Socket
308+6115	T-15 Star Bit Socket
308+6120	T-20 Star Bit Socket
308+6125	T-25 Star Bit Socket
308+6127	T-27 Star Bit Socket
308+6130	T-30 Star Bit Socket
308+6140	T-40 Star Bit Socket
310+6245	T-45 Star Bit Socket
310+6250	T-50 Star Bit Socket
340+6255	T-55 Star Bit Socket

540 g CODE : 002760
36 Sets / 20.5 Kgs / 0.73 CUFT



BS-310T

BS-310TL 10 Piece Star Bit Socket Set

Item No.	Description
3/8" Dr. Star Bit Socket 110mmL:	
308+6510	T-10 Star Bit Socket
308+6515	T-15 Star Bit Socket
308+6520	T-20 Star Bit Socket
308+6525	T-25 Star Bit Socket
308+6527	T-27 Star Bit Socket
308+6530	T-30 Star Bit Socket
308+6540	T-40 Star Bit Socket
310+6545	T-45 Star Bit Socket
310+6550	T-50 Star Bit Socket
340+6555	T-55 Star Bit Socket

725 g CODE : 004650
20 Sets / 15.5 Kgs / 0.82 CUFT



BS-310TL

BS-320TX 20 Piece Star Bit Socket Set

Item No.	Description
3/8" Dr. Star Bit Socket 50mmL:	
308+6110	T-10 Star Bit Socket
308+6115	T-15 Star Bit Socket
308+6120	T-20 Star Bit Socket
308+6125	T-25 Star Bit Socket
308+6127	T-27 Star Bit Socket
308+6130	T-30 Star Bit Socket
308+6140	T-40 Star Bit Socket
310+6245	T-45 Star Bit Socket
310+6250	T-50 Star Bit Socket
340+6255	T-55 Star Bit Socket
3/8" Dr. Star Bit Socket 180mmL:	
308+6710	T-10 Star Bit Socket
308+6715	T-15 Star Bit Socket
308+6720	T-20 Star Bit Socket
308+6725	T-25 Star Bit Socket
308+6727	T-27 Star Bit Socket
308+6730	T-30 Star Bit Socket
308+6740	T-40 Star Bit Socket
310+6745	T-45 Star Bit Socket
310+6750	T-50 Star Bit Socket
340+6755	T-55 Star Bit Socket

1800 g CODE : 008790
6 Sets / 12 Kgs / 1.21 CUFT



BS-320TX

3/8

Star Bit Sockets



Tamperproof Star Bit Sockets

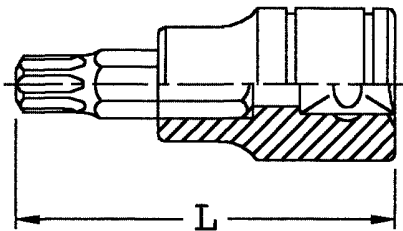

ITEM NO.	Size	Length mm	Weight g	PCS 	G.W. KGS	CUFT 	CODE @
308+7110	T-10	50	40	240	11.0	0.30	000315
308+7115	T-15	50	40	240	11.0	0.30	000315
308+7120	T-20	50	40	240	11.0	0.30	000315
308+7125	T-25	50	40	240	11.0	0.30	000315
308+7127	T-27	50	40	240	11.0	0.30	000315
308+7130	T-30	50	40	240	11.0	0.30	000315
308+7140	T-40	50	40	240	11.0	0.30	000315
310+7145	T-45	50	45	240	12.0	0.30	000355
310+7150	T-50	50	50	240	13.0	0.30	000355
340+7155	T-55	50	65	240	17.0	0.30	000450

308+7510	T-10	110	55	200	12.0	0.59	000530
308+7515	T-15	110	55	200	12.0	0.59	000530
308+7520	T-20	110	55	200	12.0	0.59	000530
308+7525	T-25	110	55	200	12.0	0.59	000530
308+7527	T-27	110	55	200	12.0	0.59	000530
308+7530	T-30	110	55	200	12.0	0.59	000530
308+7540	T-40	110	55	200	12.0	0.59	000530
310+7545	T-45	110	70	200	15.0	0.59	000570
310+7550	T-50	110	70	200	15.0	0.59	000570
340+7555	T-55	110	100	200	21.0	0.59	000710

308+7610	T-10	140	65	150	11.0	0.52	000580
308+7615	T-15	140	65	150	11.0	0.52	000580
308+7620	T-20	140	65	150	11.0	0.52	000580
308+7625	T-25	140	65	150	11.0	0.52	000580
308+7627	T-27	140	65	150	11.0	0.52	000580
308+7630	T-30	140	65	150	11.0	0.52	000580
308+7640	T-40	140	65	150	11.0	0.52	000580
310+7645	T-45	140	90	150	15.0	0.52	000680
310+7650	T-50	140	90	150	15.0	0.52	000680
340+7655	T-55	140	130	150	20.5	0.52	000920

308+7710	T-10	180	75	100	8.0	0.62	000660
308+7715	T-15	180	75	100	8.0	0.62	000660
308+7720	T-20	180	75	100	8.0	0.62	000660
308+7725	T-25	180	75	100	8.0	0.62	000660
308+7727	T-27	180	75	100	8.0	0.62	000660
308+7730	T-30	180	75	100	8.0	0.62	000660
308+7740	T-40	180	75	100	8.0	0.62	000660
310+7745	T-45	180	100	100	10.5	0.62	000790
310+7750	T-50	180	100	100	10.5	0.62	000790
340+7755	T-55	180	150	100	15.5	0.62	001030

308+7810	T-10	220	85	100	10.0	0.62	000740
308+7815	T-15	220	85	100	10.0	0.62	000740
308+7820	T-20	220	85	100	10.0	0.62	000740
308+7825	T-25	220	85	100	10.0	0.62	000740
308+7827	T-27	220	85	100	10.0	0.62	000740
308+7830	T-30	220	85	100	10.0	0.62	000740
308+7840	T-40	220	85	100	10.0	0.62	000740
310+7845	T-45	220	120	100	13.0	0.62	000890
310+7850	T-50	220	120	100	13.0	0.62	000890
340+7855	T-55	220	180	100	19.0	0.62	001130

BS-2326TAL 26 Piece Tamperproof Star Bit Socket Set

Item No.	Description
1/4" Dr. Tamperproof Star Bit Socket 45mmL:	
208 + 7107	T-7 Tamperproof Star Bit Socket
208 + 7108	T-8 Tamperproof Star Bit Socket
208 + 7109	T-9 Tamperproof Star Bit Socket
208 + 7110	T-10 Tamperproof Star Bit Socket
208 + 7115	T-15 Tamperproof Star Bit Socket
208 + 7120	T-20 Tamperproof Star Bit Socket
208 + 7125	T-25 Tamperproof Star Bit Socket
208 + 7127	T-27 Tamperproof Star Bit Socket
208 + 7130	T-30 Tamperproof Star Bit Socket
208 + 7140	T-40 Tamperproof Star Bit Socket
3/8" Dr. Tamperproof Star Bit Socket 50mmL:	
310 + 7145	T-45 Tamperproof Star Bit Socket
310 + 7150	T-50 Tamperproof Star Bit Socket
340 + 7155	T-55 Tamperproof Star Bit Socket
1/4" Dr. Tamperproof Star Bit Socket 140mmL:	
208 + 7607	T-7 Tamperproof Star Bit Socket
208 + 7608	T-8 Tamperproof Star Bit Socket
208 + 7609	T-9 Tamperproof Star Bit Socket
208 + 7610	T-10 Tamperproof Star Bit Socket
208 + 7615	T-15 Tamperproof Star Bit Socket
208 + 7620	T-20 Tamperproof Star Bit Socket
208 + 7625	T-25 Tamperproof Star Bit Socket
208 + 7627	T-27 Tamperproof Star Bit Socket
208 + 7630	T-30 Tamperproof Star Bit Socket
208 + 7640	T-40 Tamperproof Star Bit Socket
3/8" Dr. Tamperproof Star Bit Socket 140mmL:	
310 + 7645	T-45 Tamperproof Star Bit Socket
310 + 7650	T-50 Tamperproof Star Bit Socket
340 + 7655	T-55 Tamperproof Star Bit Socket

1530 g CODE : 010250
 6 Sets / 10 Kgs / 1.21 CUFT

BS-320TAX 20 Piece Tamperproof Star Bit Socket Set

Item No.	Description
3/8" Dr. Tamperproof Star Bit Socket 50mmL:	
308 + 7110	T-10 Tamperproof Star Bit Socket
308 + 7115	T-15 Tamperproof Star Bit Socket
308 + 7120	T-20 Tamperproof Star Bit Socket
308 + 7125	T-25 Tamperproof Star Bit Socket
308 + 7127	T-27 Tamperproof Star Bit Socket
308 + 7130	T-30 Tamperproof Star Bit Socket
308 + 7140	T-40 Tamperproof Star Bit Socket
310 + 7145	T-45 Tamperproof Star Bit Socket
310 + 7150	T-50 Tamperproof Star Bit Socket
340 + 7155	T-55 Tamperproof Star Bit Socket
3/8" Dr. Tamperproof Star Bit Socket 180mmL:	
308 + 7710	T-10 Tamperproof Star Bit Socket
308 + 7715	T-15 Tamperproof Star Bit Socket
308 + 7720	T-20 Tamperproof Star Bit Socket
308 + 7725	T-25 Tamperproof Star Bit Socket
308 + 7727	T-27 Tamperproof Star Bit Socket
308 + 7730	T-30 Tamperproof Star Bit Socket
308 + 7740	T-40 Tamperproof Star Bit Socket
310 + 7745	T-45 Tamperproof Star Bit Socket
310 + 7750	T-50 Tamperproof Star Bit Socket
340 + 7755	T-55 Tamperproof Star Bit Socket

1820 g CODE : 009540
 12 Sets / 23 Kgs / 1.16 CUFT

BS-310TA 10 Piece Tamperproof Star Bit Socket Set

Item No.	Description
3/8" Dr. Tamperproof Star Bit Socket 50mmL:	
308 + 7110	T-10 Tamperproof Star Bit Socket
308 + 7115	T-15 Tamperproof Star Bit Socket
308 + 7120	T-20 Tamperproof Star Bit Socket
308 + 7125	T-25 Tamperproof Star Bit Socket
308 + 7127	T-27 Tamperproof Star Bit Socket
308 + 7130	T-30 Tamperproof Star Bit Socket
308 + 7140	T-40 Tamperproof Star Bit Socket
310 + 7145	T-45 Tamperproof Star Bit Socket
310 + 7150	T-50 Tamperproof Star Bit Socket
340 + 7155	T-55 Tamperproof Star Bit Socket

540 g CODE : 003030
 36 Sets / 20.5 Kgs / 0.73 CUFT



BS-310TA



BS-2326TAL

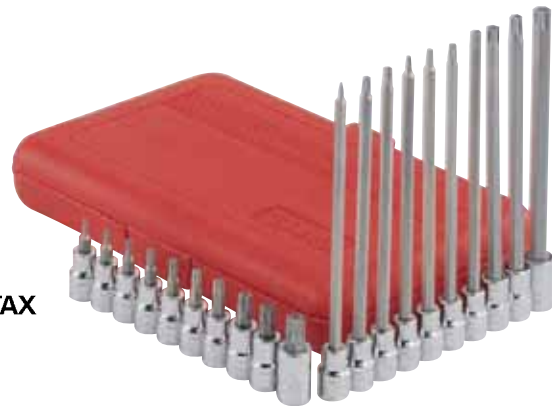

BS-320TAX

BS-310TAL 10 Piece Tamperproof Star Bit Socket Set

Item No.	Description
3/8" Dr. Tamperproof Star Bit Socket 110mmL:	
308 + 7510	T-10 Tamperproof Star Bit Socket
308 + 7515	T-15 Tamperproof Star Bit Socket
308 + 7520	T-20 Tamperproof Star Bit Socket
308 + 7525	T-25 Tamperproof Star Bit Socket
308 + 7527	T-27 Tamperproof Star Bit Socket
308 + 7530	T-30 Tamperproof Star Bit Socket
308 + 7540	T-40 Tamperproof Star Bit Socket
310 + 7545	T-45 Tamperproof Star Bit Socket
310 + 7550	T-50 Tamperproof Star Bit Socket
340 + 7555	T-55 Tamperproof Star Bit Socket

730 g CODE : 005000
 20 Sets / 16 Kgs / 0.82 CUFT





BS-310TAL

3/8

Triple Square Bit Sockets

Triple Square Bit Sockets



ITEM NO.	Size	Length mm	Weight g	PCS 	G.W. KGS	CUFT 	CODE @
308+8104	M4	50	40	240	11.0	0.30	000290
308+8105	M5	50	40	240	11.0	0.30	000290
308+8106	M6	50	40	240	11.0	0.30	000290
310+8108	M8	50	45	240	12.0	0.30	000325
340+8110	M10	50	65	240	17.0	0.30	000420
342+8112	M12	50	75	240	19.0	0.30	000465
344+8114	M14	50	90	240	23.0	0.30	000510
308+8504	M4	110	55	200	12.0	0.59	000490
308+8505	M5	110	55	200	12.0	0.59	000490
308+8506	M6	110	55	200	12.0	0.59	000490
310+8508	M8	110	70	200	15.0	0.59	000530
340+8510	M10	110	100	200	21.0	0.59	000670
342+8512	M12	110	130	200	27.0	0.59	000810
344+8514	M14	110	155	160	26.0	0.44	000950
308+8604	M4	140	65	150	11.0	0.52	000530
308+8605	M5	140	65	150	11.0	0.52	000530
308+8606	M6	140	65	150	11.0	0.52	000530
310+8608	M8	140	85	150	14.0	0.52	000630
340+8610	M10	140	130	150	21.0	0.52	000870
342+8612	M12	140	170	150	27.0	0.52	001020
344+8614	M14	140	200	100	21.0	0.34	001170
308+8704	M4	180	75	100	8.0	0.62	000610
308+8705	M5	180	75	100	8.0	0.62	000610
308+8706	M6	180	75	100	8.0	0.62	000610
310+8708	M8	180	100	100	10.5	0.62	000730
340+8710	M10	180	150	100	15.5	0.62	000970
342+8712	M12	180	200	100	20.5	0.62	001150
344+8714	M14	180	245	80	20.0	0.44	001320
308+8804	M4	220	85	100	9.5	0.62	000680
308+8805	M5	220	85	100	9.5	0.62	000680
308+8806	M6	220	85	100	9.5	0.62	000680
310+8808	M8	220	120	100	13.0	0.62	000830
340+8810	M10	220	180	100	19.0	0.62	001070
342+8812	M12	220	240	100	25.0	0.62	001270
344+8814	M14	220	290	80	24.5	0.44	001470

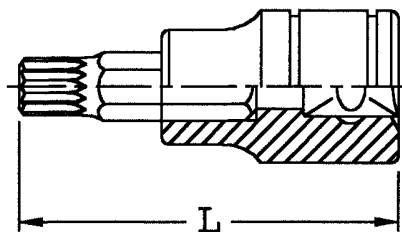

Triple Square Bit Socket Sets

3/8

BS-2314TR 14 Piece Triple Square Bit Socket Set

Item No.	Description
1/4" Dr. Triple Square Bit Socket 45mmL:	
208 + 8104	M4 Triple Square Bit Socket
208 + 8105	M5 Triple Square Bit Socket
208 + 8106	M6 Triple Square Bit Socket
3/8" Dr. Triple Square Bit Socket 50mmL:	
310 + 8108	M8 Triple Square Socket
340 + 8110	M10 Triple Square Socket
342 + 8112	M12 Triple Square Socket
344 + 8114	M14 Triple Square Socket
1/4" Dr. Triple Square Bit Socket 140mmL:	
208 + 8604	M4 Triple Square Bit Socket
208 + 8605	M5 Triple Square Bit Socket
208 + 8606	M6 Triple Square Bit Socket
3/8" Dr. Triple Square Bit Socket 140mmL:	
310 + 8608	M8 Triple Square Bit Socket
340 + 8610	M10 Triple Square Bit Socket
342 + 8612	M12 Triple Square Bit Socket
344 + 8614	M14 Triple Square Bit Socket

1260 g CODE : 006810
8 Sets / 11 Kgs / 0.88 CUFT

BS-314MX 14 Piece Triple Square Bit Socket Set

Item No.	Description
3/8" Dr. Triple Square Bit Socket 50mmL:	
308 + 8104	M4 Triple Square Bit Socket
308 + 8105	M5 Triple Square Bit Socket
308 + 8106	M6 Triple Square Bit Socket
310 + 8108	M8 Triple Square Socket
340 + 8110	M10 Triple Square Socket
342 + 8112	M12 Triple Square Socket
344 + 8114	M14 Triple Square Socket
3/8" Dr. Triple Square Bit Socket 180mmL:	
308 + 8704	M4 Triple Square Bit Socket
308 + 8705	M5 Triple Square Bit Socket
308 + 8706	M6 Triple Square Bit Socket
310 + 8708	M8 Triple Square Bit Socket
340 + 8710	M10 Triple Square Bit Socket
342 + 8712	M12 Triple Square Bit Socket
344 + 8714	M14 Triple Square Bit Socket

1800 g CODE : 007730
12 Sets / 23 Kgs / 1.16 CUFT

BS-307M 7 Piece Triple Square Bit Socket Set

Item No.	Description
3/8" Dr. Triple Square Bit Socket 50mmL:	
308 + 8104	M4 Triple Square Bit Socket
308 + 8105	M5 Triple Square Bit Socket
308 + 8106	M6 Triple Square Bit Socket
310 + 8108	M8 Triple Square Socket
340 + 8110	M10 Triple Square Socket
342 + 8112	M12 Triple Square Socket
344 + 8114	M14 Triple Square Socket

495 g CODE : 002330
36 Sets / 19 Kgs / 0.73 CUFT

BS-307ML 7 Piece Triple Square Bit Socket Set

Item No.	Description
3/8" Dr. Triple Square Bit Socket 110mmL:	
308 + 8504	M4 Triple Square Bit Socket
308 + 8505	M5 Triple Square Bit Socket
308 + 8506	M6 Triple Square Bit Socket
310 + 8508	M8 Triple Square Socket
340 + 8510	M10 Triple Square Socket
342 + 8512	M12 Triple Square Socket
344 + 8514	M14 Triple Square Socket

720 g CODE : 003990
20 Sets / 15.5 Kgs / 0.82 CUFT

BS-2314TR

BS-314MX



BS-307ML

BS-307M

1/2

Bit Sockets

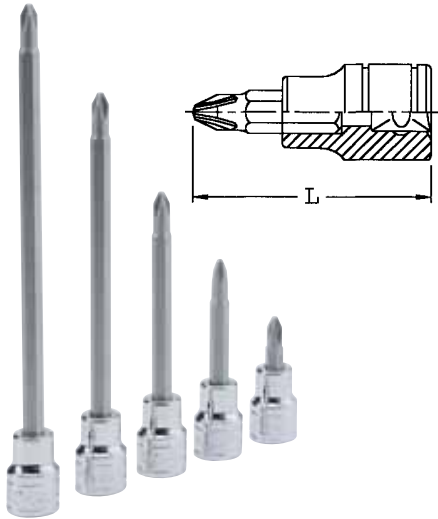
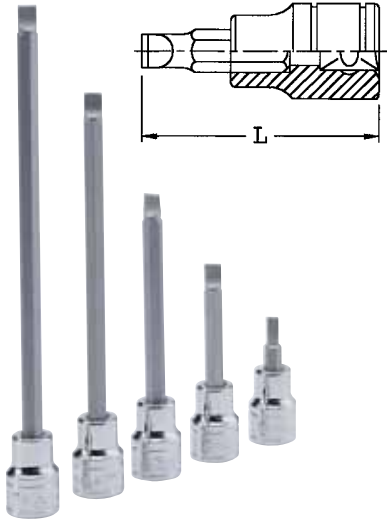

BS-3424P

Slotted Bit Sockets

ITEM NO.	Size mm	Length mm	Weight g	PCS 	G.W. KGS	CUFT 	CODE @
410 + 1480	1.2X8.0	80	80	200	17.0	0.59	000500
410 + 1490	1.6X9.0	80	110	200	23.0	0.59	000500
440 + 1492	2.0X12.0	80	140	150	22.0	0.52	000580
442 + 1494	2.5X14.0	80	140	150	22.0	0.52	000640
444 + 1496	2.5X16.0	80	170	150	26.5	0.52	000700
410 + 1580	1.2X8.0	110	95	200	20.0	0.59	000640
410 + 1590	1.6X9.0	110	130	200	27.0	0.59	000640
440 + 1592	2.0X12.0	110	170	100	18.0	0.62	000760
442 + 1594	2.5X14.0	110	170	100	18.0	0.62	000900
444 + 1596	2.5X16.0	110	210	100	22.0	0.62	001040
410 + 1680	1.2X8.0	150	105	150	17.0	0.52	000740
410 + 1690	1.6X9.0	150	105	150	17.0	0.52	000740
440 + 1692	2.0X12.0	150	145	100	15.5	0.62	000960
442 + 1694	2.5X14.0	150	200	100	21.0	0.62	001110
444 + 1696	2.5X16.0	150	230	100	24.0	0.62	001260
410 + 1780	1.2X8.0	190	120	100	12.5	0.62	000840
410 + 1790	1.6X9.0	190	120	100	12.5	0.62	000840
440 + 1792	2.0X12.0	190	170	100	17.5	0.62	001060
442 + 1794	2.5X14.0	190	230	80	19.0	0.44	001240
444 + 1796	2.5X16.0	190	275	50	14.5	0.62	001410
410 + 1880	1.2X8.0	230	140	100	15.0	0.62	000940
410 + 1890	1.6X9.0	230	140	100	15.0	0.62	000940
440 + 1892	2.0X12.0	230	195	100	20.5	0.62	001160
442 + 1894	2.5X14.0	230	270	80	23.0	0.44	001360
444 + 1896	2.5X16.0	230	320	50	17.0	0.62	001560

Philips Bit Sockets



ITEM NO.	Size	Length mm	Weight g	PCS 	G.W. KGS	CUFT 	CODE @
408 + 1302	#2	80	70	200	15.0	0.59	000460
408 + 1303	#3	80	70	200	15.0	0.59	000460
410 + 1404	#4	80	80	200	17.0	0.59	000500
408 + 1502	#2	110	75	200	16.0	0.59	000600
408 + 1503	#3	110	75	200	16.0	0.59	000600
410 + 1504	#4	110	95	200	20.0	0.59	000640
408 + 1602	#2	150	85	150	14.0	0.52	000640
408 + 1603	#3	150	85	150	14.0	0.52	000640
410 + 1604	#4	150	110	150	17.5	0.52	000740
408 + 1702	#2	190	100	100	10.5	0.62	000720
408 + 1703	#3	190	100	100	10.5	0.62	000720
410 + 1704	#4	190	125	100	13.0	0.62	000840
408 + 1802	#2	230	110	100	12.0	0.62	000790
408 + 1803	#3	230	110	100	12.0	0.62	000790
410 + 1804	#4	230	140	100	15.0	0.62	000940

BS-3424P 24 Piece Slotted & Philips Bit Socket Set

Item No.	Description	Item No.	Description	Item No.	Description
3/8" Dr. Slotted Bit Socket 50mmL:		310 + 1690	1.6 x 9.0 Slotted Bit Socket	308 + 1102	#2 Philips Bit Socket
308 + 1140	0.6 x 4.0 Slotted Bit Socket	1/2" Dr. Slotted Bit Socket 80mmL:		3/8" Dr. Philips Bit Socket 140mmL:	
308 + 1150	0.8 x 5.0 Slotted Bit Socket	440 + 1492	2.0 x 12.0 Slotted Bit Socket	308 + 1601	#1 Philips Bit Socket
308 + 1160	1.0 x 6.0 Slotted Bit Socket	442 + 1494	2.5 x 14.0 Slotted Bit Socket	308 + 1602	#2 Philips Bit Socket
310 + 1280	1.2 x 8.0 Slotted Bit Socket	444 + 1496	2.5 x 16.0 Slotted Bit Socket	1/2" Dr. Philips Bit Socket 80mmL:	
310 + 1290	1.6 x 9.0 Slotted Bit Socket	1/2" Dr. Slotted Bit Socket 150mmL:		408 + 1303	#3 Philips Bit Socket
3/8" Dr. Slotted Bit Socket 140mmL:		440 + 1692	2.0 x 12.0 Slotted Bit Socket	410 + 1404	#4 Philips Bit Socket
308 + 1640	0.6 x 4.0 Slotted Bit Socket	442 + 1694	2.5 x 14.0 Slotted Bit Socket	1/2" Dr. Philips Bit Socket 150mmL:	
308 + 1650	0.8 x 5.0 Slotted Bit Socket	444 + 1696	2.5 x 16.0 Slotted Bit Socket	408 + 1603	#3 Philips Bit Socket
308 + 1660	1.0 x 6.0 Slotted Bit Socket	3/8" Dr. Philips Bit Socket 50mmL:		410 + 1604	#4 Philips Bit Socket
310 + 1680	1.2 x 8.0 Slotted Bit Socket	308 + 1101	#1 Philips Bit Socket	Plastic Tray (1/3)	

2770 g 5 Sets / 15 Kgs / 0.93 CUFT CODE : 012210

Metric Hex Bit Sockets

ITEM NO.	Size mm	Length mm	Weight g	PCS 	G.W. KGS	CUFT 	CODE @
408+2334	4	80	65	200	14.0	0.59	000460
408+2335	5	80	70	200	15.0	0.59	000460
408+2336	6	80	70	200	15.0	0.59	000460
410+2347	7	80	80	200	17.0	0.59	000500
410+2348	8	80	80	200	17.0	0.59	000500
439+2349	9	80	95	200	20.0	0.59	000580
440+2350	10	80	100	200	21.0	0.59	000580
441+2351	11	80	115	150	18.5	0.52	000640
442+2352	12	80	130	150	20.5	0.52	000640
443+2353	13	80	140	150	22.0	0.52	000670
444+2354	14	80	150	150	23.5	0.52	000700
446+2356	16	80	195	100	20.5	0.34	000800
447+2357	17	80	210	100	22.0	0.34	000890
449+2359	19	80	250	100	26.0	0.34	000990

408+2534	4	110	75	200	16.0	0.59	000600
408+2535	5	110	75	200	16.0	0.59	000600
408+2536	6	110	75	200	16.0	0.59	000600
410+2547	7	110	90	200	19.0	0.59	000640
410+2548	8	110	95	200	20.0	0.59	000640
439+2549	9	110	115	200	24.0	0.59	000760
440+2550	10	110	120	200	25.0	0.59	000760
441+2551	11	110	140	100	15.0	0.62	000900
442+2552	12	110	160	100	17.0	0.62	000900
443+2553	13	110	170	100	18.0	0.62	001040
444+2554	14	110	185	100	19.5	0.62	001040
446+2556	16	110	250	100	26.0	0.62	001160
447+2557	17	110	270	80	23.0	0.44	001230
449+2559	19	110	320	80	27.0	0.44	001370

408+2634	4	150	85	150	14.0	0.52	000640
408+2635	5	150	85	150	14.0	0.52	000640
408+2636	6	150	85	150	14.0	0.52	000640
410+2647	7	150	110	150	17.5	0.52	000760
410+2648	8	150	110	150	17.5	0.52	000760
439+2649	9	150	125	150	20.0	0.52	000960
440+2650	10	150	145	150	23.0	0.52	000960
441+2651	11	150	170	100	18.0	0.62	001110
442+2652	12	150	195	100	20.5	0.62	001110
443+2653	13	150	210	100	22.0	0.62	001260
444+2654	14	150	230	100	24.0	0.62	001260
446+2656	16	150	320	80	27.0	0.44	001440
447+2657	17	150	340	50	18.0	0.62	001570
449+2659	19	150	400	50	21.0	0.62	001760

408+2734	4	190	100	100	10.5	0.62	000720
408+2735	5	190	100	100	10.5	0.62	000720
408+2736	6	190	100	100	10.5	0.62	000720
410+2747	7	190	130	100	13.5	0.62	000840
410+2748	8	190	130	100	13.5	0.62	000840
439+2749	9	190	155	100	16.0	0.62	001060
440+2750	10	190	170	100	17.5	0.62	001060
441+2751	11	190	200	80	16.5	0.44	001240
442+2752	12	190	230	80	19.0	0.44	001240
443+2753	13	190	250	50	13.0	0.62	001410
444+2754	14	190	275	50	14.0	0.62	001410
446+2756	16	190	390	50	20.0	0.62	001620
447+2757	17	190	410	50	21.0	0.62	001750
449+2759	19	190	480	40	20.0	0.44	001970

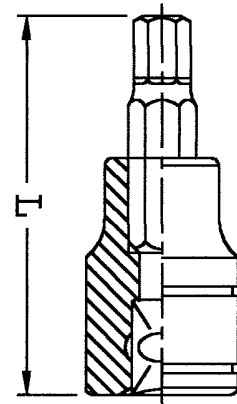



Hex Bit Sockets

Metric Hex Bit Sockets

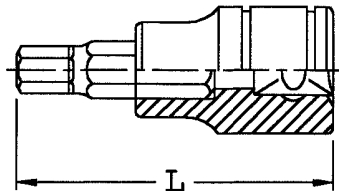
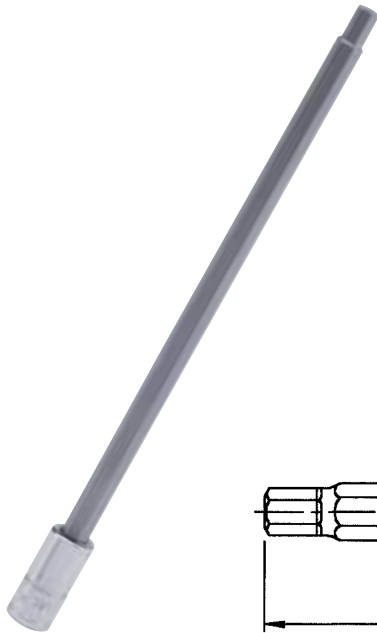

ITEM NO.	Size mm	Length mm	Weight g	PCS	G.W. KGS	CUFT	CODE @
408 + 2836	6	230	140	100	15.0	0.62	000790
410 + 2847	7	230	140	100	15.0	0.62	000940
410 + 2848	8	230	140	100	15.0	0.62	000940
439 + 2849	9	230	175	100	18.5	0.62	001160
440 + 2850	10	230	195	100	20.5	0.62	001160
441 + 2851	11	230	230	80	19.5	0.44	001360
442 + 2852	12	230	270	80	23.0	0.44	001360
443 + 2853	13	230	290	50	15.5	0.62	001560
444 + 2854	14	230	320	50	17.0	0.62	001560
446 + 2856	16	230	460	50	24.0	0.62	001790
447 + 2857	17	230	490	50	25.5	0.62	001930
449 + 2859	19	230	565	40	24.0	0.44	002170

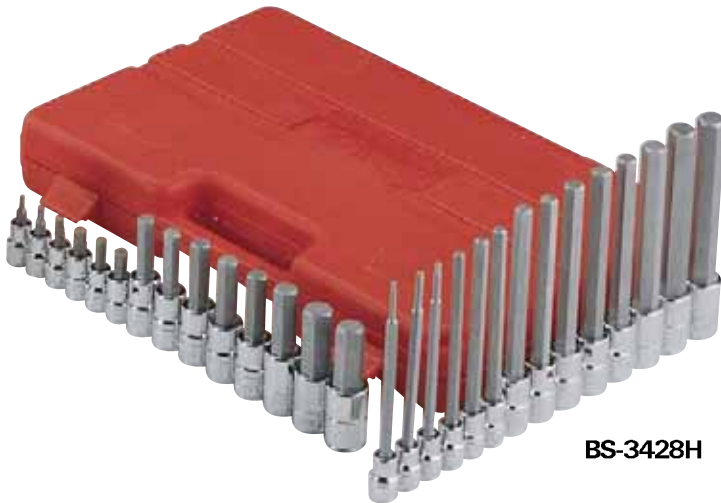

BS-3428H

BS-3428H 28 Piece Metric Hex Bit Socket Set

- Item No. Description**
- 3/8" Dr. Metric Hex Bit Socket 50mmL:**
- 308 + 2133 3mm Hex Bit Socket
 - 308 + 2134 4mm Hex Bit Socket
 - 308 + 2135 5mm Hex Bit Socket
 - 308 + 2136 6mm Hex Bit Socket
 - 310 + 2147 7mm Hex Bit Socket
 - 310 + 2148 8mm Hex Bit Socket
- 3/8" Dr. Metric Hex Bit Socket 140 mmL:**
- 308 + 2633 3mm Hex Bit Socket
 - 308 + 2634 4mm Hex Bit Socket
 - 308 + 2635 5mm Hex Bit Socket
 - 308 + 2636 6mm Hex Bit Socket
 - 310 + 2647 7mm Hex Bit Socket
 - 310 + 2648 8mm Hex Bit Socket
- 1/2" Dr. Metric Hex Bit Socket 80 mmL:**
- 439 + 2349 9mm Hex Bit Socket
 - 440 + 2350 10mm Hex Bit Socket
 - 441 + 2351 11mm Hex Bit Socket
 - 442 + 2352 12mm Hex Bit Socket
 - 443 + 2353 13mm Hex Bit Socket
 - 444 + 2354 14mm Hex Bit Socket
 - 446 + 2356 16mm Hex Bit Socket
 - 447 + 2357 17mm Hex Bit Socket
- 1/2" Dr. Metric Hex Bit Socket 150 mmL:**
- 439 + 2649 9mm Hex Bit Socket
 - 440 + 2650 10mm Hex Bit Socket
 - 441 + 2651 11mm Hex Bit Socket
 - 442 + 2652 12mm Hex Bit Socket
 - 443 + 2653 13mm Hex Bit Socket
 - 444 + 2654 14mm Hex Bit Socket
 - 446 + 2656 16mm Hex Bit Socket
 - 447 + 2657 17mm Hex Bit Socket

Blow Case

4330 g CODE : 018300

4 Sets / 18.5 Kgs / 1.07 CUFT

SAE Hex Bit Sockets

ITEM NO.	Size Inch	Length mm	Weight g	PCS 	G.W. KGS	CUFT 	CODE @
408+3310	5/32	80	65	200	14.0	0.59	000460
408+3312	3/16	80	70	200	15.0	0.59	000460
408+3314	7/32	80	70	200	15.0	0.59	000460
408+3316	1/4	80	70	200	15.0	0.59	000460
410+3318	9/32	80	80	200	17.0	0.59	000500
410+3320	5/16	80	80	200	17.0	0.59	000500
412+3324	3/8	80	100	200	21.0	0.59	000580
414+3328	7/16	80	115	150	18.5	0.52	000640
416+3332	1/2	80	135	150	21.5	0.52	000670
418+3336	9/16	80	150	150	23.5	0.52	000700
420+3340	5/8	80	190	100	20.0	0.34	000800
422+3344	11/16	80	210	100	22.0	0.34	000890
424+3348	3/4	80	250	100	26.0	0.34	000990

408+3510	5/32	110	75	200	16.0	0.59	000600
408+3512	3/16	110	75	200	16.0	0.59	000600
408+3514	7/32	110	75	200	16.0	0.59	000600
408+3516	1/4	110	75	200	16.0	0.59	000600
410+3518	9/32	110	90	200	19.0	0.59	000640
410+3520	5/16	110	95	200	20.0	0.59	000640
412+3524	3/8	110	120	200	25.0	0.59	000760
414+3528	7/16	110	140	150	22.0	0.52	000900
416+3532	1/2	110	170	100	18.0	0.62	001040
418+3536	9/16	110	190	100	20.0	0.62	001100
420+3540	5/8	110	250	100	26.0	0.62	001160
422+3544	11/16	110	275	80	23.0	0.44	001230
424+3548	3/4	110	320	80	27.0	0.44	001370

408+3610	5/32	150	85	150	14.0	0.52	000640
408+3612	3/16	150	85	150	14.0	0.52	000640
408+3614	7/32	150	85	150	14.0	0.52	000640
408+3616	1/4	150	85	150	14.0	0.52	000640
410+3618	9/32	150	110	150	17.5	0.52	000740
410+3620	5/16	150	110	150	17.5	0.52	000740
412+3624	3/8	150	145	150	23.0	0.52	000960
414+3628	7/16	150	170	100	18.5	0.62	001110
416+3632	1/2	150	205	100	21.5	0.62	001260
418+3636	9/16	150	235	100	24.5	0.62	001340
420+3640	5/8	150	315	80	26.5	0.44	001440
422+3644	11/16	150	345	50	18.5	0.62	001570
424+3648	3/4	150	370	50	19.5	0.62	001760

408+3710	5/32	190	100	100	10.5	0.62	000720
408+3712	3/16	190	100	100	10.5	0.62	000720
408+3714	7/32	190	100	100	10.5	0.62	000720
408+3716	1/4	190	100	100	10.5	0.62	000720
410+3718	9/32	190	120	100	12.5	0.62	000840
410+3720	5/16	190	120	100	12.5	0.62	000840
412+3724	3/8	190	165	100	17.0	0.62	001060
414+3728	7/16	190	195	80	16.0	0.44	001240
416+3732	1/2	190	240	50	12.5	0.62	001410
418+3736	9/16	190	375	50	19.5	0.62	001500
420+3740	5/8	190	380	50	19.5	0.62	001620
422+3744	11/16	190	420	50	21.5	0.62	001750
424+3748	3/4	190	450	40	18.5	0.44	001970

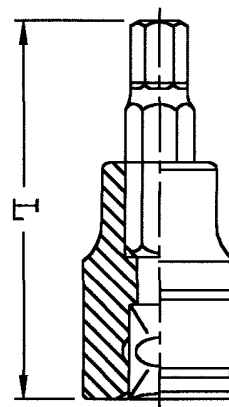

1/2

Hex Bit Sockets



SAE Hex Bit Sockets

ITEM NO.	Size Inch	Length mm	Weight g	PCS 	G.W. KGS	CUFT 	CODE @
408 + 3816	1/4	230	110	100	12.0	0.62	000790
410 + 3818	9/32	230	140	100	15.0	0.62	000940
410 + 3820	5/16	230	140	100	15.0	0.62	000940
412 + 3824	3/8	230	190	100	20.0	0.62	001140
414 + 3828	7/16	230	235	80	20.0	0.44	001360
416 + 3832	1/2	230	285	50	15.5	0.62	001560
418 + 3836	9/16	230	325	50	17.5	0.62	001660
420 + 3840	5/8	230	455	50	24.0	0.62	001790
422 + 3844	11/16	230	500	50	26.0	0.62	001930
424 + 3848	3/4	230	565	40	24.0	0.44	002170

BS-3424H 24 Piece SAE Hex Bit Socket Set

Item No. Description

3/8" Dr. SAE Hex Bit Socket 50mmL:

- 308 + 3108 1/8" Hex Bit Socket
- 308 + 3110 5/32" Hex Bit Socket
- 308 + 3112 3/16" Hex Bit Socket
- 308 + 3114 7/32" Hex Bit Socket
- 308 + 3116 1/4" Hex Bit Socket
- 310 + 3128 9/32" Hex Bit Socket
- 310 + 3130 5/16" Hex Bit Socket

3/8" Dr. SAE Hex Bit Socket 140mmL:

- 308 + 3608 1/8" Hex Bit Socket
- 308 + 3610 5/32" Hex Bit Socket
- 308 + 3612 3/16" Hex Bit Socket
- 308 + 3614 7/32" Hex Bit Socket
- 308 + 3616 1/4" Hex Bit Socket
- 310 + 3618 9/32" Hex Bit Socket
- 310 + 3620 5/16" Hex Bit Socket

1/2" Dr. SAE Hex Bit Socket 80 mmL:

- 412 + 3324 3/8" Hex Bit Socket
- 414 + 3328 7/16" Hex Bit Socket
- 416 + 3332 1/2" Hex Bit Socket
- 418 + 3336 9/16" Hex Bit Socket
- 420 + 3340 5/8" Hex Bit Socket

1/2" Dr. SAE Hex Bit Socket 150 mmL:

- 412 + 3624 3/8" Hex Bit Socket
- 414 + 3628 7/16" Hex Bit Socket
- 416 + 3632 1/2" Hex Bit Socket
- 418 + 3636 9/16" Hex Bit Socket
- 420 + 3640 5/8" Hex Bit Socket

Plastic Tray (1/3)



3245 g CODE : 013930

5 Sets / 17.5 Kgs / 0.93 CUFT



BS-3424H

Metric Wobble Hex Bit Sockets

ITEM NO.	Size mm	Length mm	Weight g	PCS 	G.W. KGS	CUFT 	CODE @
408 + 4335	5	80	65	200	14.0	0.59	000490
408 + 4336	6	80	70	200	15.0	0.59	000490
410 + 4347	7	80	80	200	17.0	0.59	000530
410 + 4348	8	80	80	200	17.0	0.59	000530
439 + 4349	9	80	100	200	21.0	0.59	000610
440 + 4350	10	80	110	200	23.0	0.59	000610
408 + 4535	5	110	75	200	16.0	0.59	000640
408 + 4536	6	110	75	200	16.0	0.59	000640
410 + 4547	7	110	90	200	19.0	0.59	000680
410 + 4548	8	110	90	200	19.0	0.59	000680
439 + 4549	9	110	115	200	24.0	0.59	000800
440 + 4550	10	110	130	200	27.0	0.59	000800
408 + 4635	5	150	85	150	13.8	0.52	000690
408 + 4636	6	150	85	150	13.8	0.52	000690
410 + 4647	7	150	110	150	17.5	0.52	000790
410 + 4648	8	150	110	150	17.5	0.52	000790
439 + 4649	9	150	140	150	22.0	0.52	001010
440 + 4650	10	150	160	150	25.0	0.52	001010
408 + 4735	5	190	100	100	10.5	0.62	000770
408 + 4736	6	190	100	100	10.5	0.62	000770
410 + 4747	7	190	120	100	12.5	0.62	000900
410 + 4748	8	190	120	100	12.5	0.62	000900
439 + 4749	9	190	155	100	16.0	0.62	001120
440 + 4750	10	190	170	100	17.5	0.62	001120
408 + 4836	6	230	110	100	12.0	0.62	000850
410 + 4847	7	230	140	100	15.0	0.62	001000
410 + 4848	8	230	140	100	15.0	0.62	001000
439 + 4849	9	230	180	100	19.0	0.62	001220
440 + 4850	10	230	210	100	22.0	0.62	001220



BS-3416WM 16 Piece Metric Wobble Hex Bit Socket Set

Item No.	Description
3/8" Dr. Metric Wobble Hex Bit Socket 50mmL:	
308 + 4133	3mm Wobble Hex Bit Socket
308 + 4134	4mm Wobble Hex Bit Socket
308 + 4135	5mm Wobble Hex Bit Socket
308 + 4136	6mm Wobble Hex Bit Socket
3/8" Dr. Metric Wobble Hex Bit Socket 140mmL:	
308 + 4633	3mm Wobble Hex Bit Socket
308 + 4634	4mm Wobble Hex Bit Socket
308 + 4635	5mm Wobble Hex Bit Socket
308 + 4636	6mm Wobble Hex Bit Socket
1/2" Dr. Metric Wobble Hex Bit Socket 80mmL:	
410 + 4347	7mm Wobble Hex Bit Socket
410 + 4348	8mm Wobble Hex Bit Socket
439 + 4349	9mm Wobble Hex Bit Socket
440 + 4350	10mm Wobble Hex Bit Socket
1/2" Dr. Metric Wobble Hex Bit Socket 150mmL:	
410 + 4647	7mm Wobble Hex Bit Socket
410 + 4648	8mm Wobble Hex Bit Socket
439 + 4649	9mm Wobble Hex Bit Socket
440 + 4650	10mm Wobble Hex Bit Socket

Blow Case

 1560 g CODE : 008510

 12 Sets / 20 Kgs / 1.16 CUFT

BS-3416WM



1/2

Wobble Hex Bit Sockets

SAE Wobble Hex Bit Sockets



ITEM NO.	Size Inch	Length mm	Weight g	PCS 	G.W. KGS	CUFT 	CODE @
408 + 5312	3/16	80	65	200	14.0	0.59	000490
408 + 5314	7/32	80	70	200	15.0	0.59	000490
408 + 5316	1/4	80	70	200	15.0	0.59	000490
410 + 5318	9/32	80	80	200	17.0	0.59	000530
410 + 5320	5/16	80	80	200	17.0	0.59	000530
412 + 5324	3/8	80	110	200	23.0	0.59	000610
408 + 5512	3/16	110	75	200	16.0	0.59	000640
408 + 5514	7/32	110	75	200	16.0	0.59	000640
408 + 5516	1/4	110	75	200	16.0	0.59	000640
410 + 5518	9/32	110	90	200	19.0	0.59	000680
410 + 5520	5/16	110	95	200	20.0	0.59	000680
412 + 5524	3/8	110	130	200	27.0	0.59	000800
408 + 5612	3/16	150	85	150	14.0	0.52	000690
408 + 5614	7/32	150	85	150	14.0	0.52	000690
408 + 5616	1/4	150	85	150	14.0	0.52	000690
410 + 5618	9/32	150	110	150	17.5	0.52	000790
410 + 5620	5/16	150	110	150	17.5	0.52	000790
412 + 5624	3/8	150	150	150	23.5	0.52	001010
408 + 5712	3/16	190	100	100	10.5	0.62	000770
408 + 5714	7/32	190	100	100	10.5	0.62	000770
408 + 5716	1/4	190	100	100	10.5	0.62	000770
410 + 5718	9/32	190	120	100	12.5	0.62	000900
410 + 5720	5/16	190	120	100	12.5	0.62	000900
412 + 5724	3/8	190	165	100	17.0	0.62	001120
408 + 5816	1/4	230	110	100	12.0	0.62	000850
410 + 5818	9/32	230	140	100	15.0	0.62	001000
410 + 5820	5/16	230	140	100	15.0	0.62	001000
412 + 5824	3/8	230	200	100	21.0	0.62	001220

BS-3416WS





BS-3416WS 16 Piece SAE Wobble Hex Bit Socket Set

Item No.	Description
3/8" Dr. SAE Wobble Hex Bit Socket 50mmL:	
308 + 5108	1/8" Wobble Hex Bit Socket
308 + 5110	5/32" Wobble Hex Bit Socket
308 + 5112	3/16" Wobble Hex Bit Socket
308 + 5114	7/32" Wobble Hex Bit Socket
308 + 5116	1/4" Wobble Hex Bit Socket
3/8" Dr. SAE Wobble Hex Bit Socket 140mmL:	
308 + 5608	1/8" Wobble Hex Bit Socket
308 + 5610	5/32" Wobble Hex Bit Socket
308 + 5612	3/16" Wobble Hex Bit Socket
308 + 5614	7/32" Wobble Hex Bit Socket
308 + 5616	1/4" Wobble Hex Bit Socket
1/2" Dr. SAE Wobble Hex Bit Socket 80mmL:	
410 + 5318	9/32" Wobble Hex Bit Socket
410 + 5320	5/16" Wobble Hex Bit Socket
412 + 5324	3/8" Wobble Hex Bit Socket
1/2" Dr. SAE Wobble Hex Bit Socket 150mmL:	
410 + 5618	9/32" Wobble Hex Bit Socket
410 + 5620	5/16" Wobble Hex Bit Socket
412 + 5624	3/8" Wobble Hex Bit Socket

1415 g CODE : 007860
 10 Sets / 15.5 Kgs / 0.93 CUFT

Star Bit Sockets

ITEM NO.	Size	Length mm	Weight g	PCS 	G.W. KGS	CUFT 	CODE @
408 + 6320	T-20	80	65	200	14.0	0.59	000460
408 + 6325	T-25	80	65	200	14.0	0.59	000460
408 + 6327	T-27	80	65	200	14.0	0.59	000460
408 + 6330	T-30	80	70	200	15.0	0.59	000460
408 + 6340	T-40	80	70	200	15.0	0.59	000460
410 + 6345	T-45	80	80	200	17.0	0.59	000500
410 + 6350	T-50	80	80	200	17.0	0.59	000500
440 + 6355	T-55	80	110	200	23.0	0.59	000580
442 + 6360	T-60	80	140	150	22.0	0.52	000640
444 + 6370	T-70	80	170	150	26.5	0.52	000700

408 + 6520	T-20	110	75	200	16.0	0.59	000600
408 + 6525	T-25	110	75	200	16.0	0.59	000600
408 + 6527	T-27	110	75	200	16.0	0.59	000600
408 + 6530	T-30	110	75	200	16.0	0.59	000600
408 + 6540	T-40	110	75	200	16.0	0.59	000600
410 + 6545	T-45	110	95	200	20.0	0.59	000640
410 + 6550	T-50	110	95	200	20.0	0.59	000640
440 + 6555	T-55	110	130	200	27.0	0.59	000760
442 + 6560	T-60	110	170	100	18.0	0.62	000900
444 + 6570	T-70	110	210	100	22.0	0.62	001040

408 + 6620	T-20	150	85	150	14.0	0.52	000640
408 + 6625	T-25	150	85	150	14.0	0.52	000640
408 + 6627	T-27	150	85	150	14.0	0.52	000640
408 + 6630	T-30	150	85	150	14.0	0.52	000640
408 + 6640	T-40	150	85	150	14.0	0.52	000640
410 + 6645	T-45	150	110	150	17.5	0.52	000740
410 + 6650	T-50	150	110	150	17.5	0.52	000740
440 + 6655	T-55	150	160	150	25.0	0.52	000960
442 + 6660	T-60	150	210	100	22.0	0.62	001110
444 + 6670	T-70	150	260	100	27.0	0.62	001260

408 + 6720	T-20	190	100	100	10.5	0.62	000720
408 + 6725	T-25	190	100	100	10.5	0.62	000720
408 + 6727	T-27	190	100	100	10.5	0.62	000720
408 + 6730	T-30	190	100	100	10.5	0.62	000720
408 + 6740	T-40	190	100	100	10.5	0.62	000720
410 + 6745	T-45	190	120	100	12.5	0.62	000840
410 + 6750	T-50	190	120	100	12.5	0.62	000840
440 + 6755	T-55	190	170	100	17.5	0.62	001060
442 + 6760	T-60	190	230	80	19.0	0.44	001240
444 + 6770	T-70	190	275	50	14.0	0.62	001410

408 + 6830	T-30	230	110	100	12.0	0.62	000790
408 + 6840	T-40	230	110	100	12.0	0.62	000790
410 + 6845	T-45	230	140	100	15.0	0.62	000940
410 + 6850	T-50	230	140	100	15.0	0.62	000940
440 + 6855	T-55	230	210	100	22.0	0.62	001160
442 + 6860	T-60	230	280	80	23.5	0.44	001360
444 + 6870	T-70	230	360	50	19.0	0.62	001560





BS-3424T

BS-3424T 24 Piece Star Bit Socket Set

Item No.	Description	Item No.	Description	Item No.	Description
3/8" Dr. Star Bit Socket 50mmL:		308 + 6615	T-15 Star Bit Socket	442 + 6360	T-60 Star Bit Socket
308 + 6110	T-10 Star Bit Socket	308 + 6620	T-20 Star Bit Socket	444 + 6370	T-70 Star Bit Socket
308 + 6115	T-15 Star Bit Socket	308 + 6625	T-25 Star Bit Socket		
308 + 6120	T-20 Star Bit Socket	308 + 6627	T-27 Star Bit Socket	1/2" Dr. Star Bit Socket 150mmL:	
308 + 6125	T-25 Star Bit Socket	308 + 6630	T-30 Star Bit Socket	410 + 6645	T-45 Star Bit Socket
308 + 6127	T-27 Star Bit Socket	308 + 6640	T-40 Star Bit Socket	410 + 6650	T-50 Star Bit Socket
308 + 6130	T-30 Star Bit Socket			440 + 6655	T-55 Star Bit Socket
308 + 6140	T-40 Star Bit Socket	1/2" Dr. Star Bit Socket 80mmL:		442 + 6660	T-60 Star Bit Socket
		410 + 6345	T-45 Star Bit Socket	444 + 6670	T-70 Star Bit Socket
3/8" Dr. Star Bit Socket 140mmL:		410 + 6350	T-50 Star Bit Socket		
308 + 6610	T-10 Star Bit Socket	440 + 6355	T-55 Star Bit Socket		

Plastic Tray (1/3)

 2665 g  5 Sets / 14.5 Kgs / 0.93 CUFT CODE : 012090



Star Bit Sockets

Tamperproof Star Bit Sockets



BS-3424TA

ITEM NO.	Size	Length mm	Weight g	PCS 	G.W. KGS	CUFT 	CODE @
408 + 7320	T-20	80	65	200	14.0	0.59	000490
408 + 7325	T-25	80	65	200	14.0	0.59	000490
408 + 7327	T-27	80	65	200	14.0	0.59	000490
408 + 7330	T-30	80	70	200	15.0	0.59	000490
408 + 7340	T-40	80	70	200	15.0	0.59	000490
410 + 7345	T-45	80	80	200	17.0	0.59	000530
410 + 7350	T-50	80	80	200	17.0	0.59	000530
440 + 7355	T-55	80	110	200	23.0	0.59	000610
442 + 7360	T-60	80	140	150	22.0	0.52	000670
444 + 7370	T-70	80	170	150	26.5	0.52	000730
408 + 7520	T-20	110	75	200	16.0	0.59	000640
408 + 7525	T-25	110	75	200	16.0	0.59	000640
408 + 7527	T-27	110	75	200	16.0	0.59	000640
408 + 7530	T-30	110	75	200	16.0	0.59	000640
408 + 7540	T-40	110	75	200	16.0	0.59	000640
410 + 7545	T-45	110	90	200	19.0	0.59	000680
410 + 7550	T-50	110	90	200	19.0	0.59	000680
440 + 7555	T-55	110	130	200	27.0	0.59	000800
442 + 7560	T-60	110	170	100	18.0	0.62	000940
444 + 7570	T-70	110	210	100	22.0	0.62	001080
408 + 7620	T-20	150	85	150	14.0	0.52	000690
408 + 7625	T-25	150	85	150	14.0	0.52	000690
408 + 7627	T-27	150	85	150	14.0	0.52	000690
408 + 7630	T-30	150	85	150	14.0	0.52	000690
408 + 7640	T-40	150	85	150	14.0	0.52	000690
410 + 7645	T-45	150	110	150	17.5	0.52	000790
410 + 7650	T-50	150	110	150	17.5	0.52	000790
440 + 7655	T-55	150	160	150	25.0	0.52	001010
442 + 7660	T-60	150	210	100	22.0	0.62	001160
444 + 7670	T-70	150	260	100	27.0	0.62	001310
408 + 7720	T-20	190	100	100	10.5	0.62	000770
408 + 7725	T-25	190	100	100	10.5	0.62	000770
408 + 7727	T-27	190	100	100	10.5	0.62	000770
408 + 7730	T-30	190	100	100	10.5	0.62	000770
408 + 7740	T-40	190	100	100	10.5	0.62	000770
410 + 7745	T-45	190	120	100	12.5	0.62	000900
410 + 7750	T-50	190	120	100	12.5	0.62	000900
440 + 7755	T-55	190	170	100	17.5	0.62	001120
442 + 7760	T-60	190	230	80	19.0	0.44	001290
444 + 7770	T-70	190	275	50	14.0	0.62	001470
408 + 7830	T-30	230	110	100	12.0	0.62	000850
408 + 7840	T-40	230	110	100	12.0	0.62	000850
410 + 7845	T-45	230	140	100	15.0	0.62	001000
410 + 7850	T-50	230	140	100	15.0	0.62	001000
440 + 7855	T-55	230	210	100	22.0	0.62	001220
442 + 7860	T-60	230	280	80	23.5	0.44	001420
444 + 7870	T-70	230	360	50	19.0	0.62	001620

BS-3424TA 24 Piece Tamperproof Star Bit Socket Set

Item No.	Description	Item No.	Description	Item No.	Description
3/8" Dr. Tamperproof Star Bit Socket 50mmL:					
308 + 7110	T-10 Tamperproof Star Bit Socket	308 + 7615	T-15 Tamperproof Star Bit Socket	442 + 7360	T-60 Tamperproof Star Bit Socket
308 + 7115	T-15 Tamperproof Star Bit Socket	308 + 7620	T-20 Tamperproof Star Bit Socket	444 + 7370	T-70 Tamperproof Star Bit Socket
308 + 7120	T-20 Tamperproof Star Bit Socket	308 + 7625	T-25 Tamperproof Star Bit Socket	1/2" Dr. Tamperproof Star Bit Socket 150mmL:	
308 + 7125	T-25 Tamperproof Star Bit Socket	308 + 7627	T-27 Tamperproof Star Bit Socket	410 + 7645	T-45 Tamperproof Star Bit Socket
308 + 7127	T-27 Tamperproof Star Bit Socket	308 + 7630	T-30 Tamperproof Star Bit Socket	410 + 7650	T-50 Tamperproof Star Bit Socket
308 + 7130	T-30 Tamperproof Star Bit Socket	308 + 7640	T-40 Tamperproof Star Bit Socket	440 + 7655	T-55 Tamperproof Star Bit Socket
308 + 7140	T-40 Tamperproof Star Bit Socket	1/2" Dr. Tamperproof Star Bit Socket 80mmL:		442 + 7660	T-60 Tamperproof Star Bit Socket
3/8" Dr. Tamperproof Star Bit Socket 140mmL:		410 + 7345	T-45 Tamperproof Star Bit Socket	444 + 7670	T-70 Tamperproof Star Bit Socket
308 + 7610	T-10 Tamperproof Star Bit Socket	410 + 7350	T-50 Tamperproof Star Bit Socket	Plastic Tray (1/3)	
		440 + 7355	T-55 Tamperproof Star Bit Socket		

BS-2328HL 28 Piece SAE Hex Bit Socket Set

Item No.	Description
1/4" Dr. SAE Hex Bit Socket 45mmL:	
208 + 3104	1/16" Hex Bit Socket
208 + 3105	5/64" Hex Bit Socket
208 + 3106	3/32" Hex Bit Socket
208 + 3107	7/64" Hex Bit Socket
208 + 3108	1/8" Hex Bit Socket
208 + 3110	5/32" Hex Bit Socket
208 + 3112	3/16" Hex Bit Socket
208 + 3114	7/32" Hex Bit Socket
208 + 3116	1/4" Hex Bit Socket
3/8" Dr. SAE Hex Bit Socket 50mmL:	
310 + 3128	9/32" Hex Bit Socket
310 + 3130	5/16" Hex Bit Socket
312 + 3134	3/8" Hex Bit Socket
314 + 3138	7/16" Hex Bit Socket
316 + 3142	1/2" Hex Bit Socket
1/4" Dr. SAE Hex Bit Socket 140mmL:	
208 + 3604	1/16" Hex Bit Socket
208 + 3605	5/64" Hex Bit Socket
208 + 3606	3/32" Hex Bit Socket
208 + 3607	7/64" Hex Bit Socket
208 + 3608	1/8" Hex Bit Socket
208 + 3610	5/32" Hex Bit Socket
208 + 3612	3/16" Hex Bit Socket
208 + 3614	7/32" Hex Bit Socket
208 + 3616	1/4" Hex Bit Socket
3/8" Dr. SAE Hex Bit Socket 140mmL:	
310 + 3618	9/32" Hex Bit Socket
310 + 3620	5/16" Hex Bit Socket
312 + 3624	3/8" Hex Bit Socket
314 + 3628	7/16" Hex Bit Socket
316 + 3632	1/2" Hex Bit Socket

Blow Case
 1790 g CODE : 011520
 6 Sets / 12 Kgs / 1.21 CUFT

BS-310HS 10 Piece SAE Hex Bit Socket Set

Item No.	Description
3/8" Dr. SAE Hex Bit Socket 50mmL:	
308 + 3108	1/8" Hex Bit Socket
308 + 3110	5/32" Hex Bit Socket
308 + 3112	3/16" Hex Bit Socket
308 + 3114	7/32" Hex Bit Socket
308 + 3116	1/4" Hex Bit Socket
310 + 3128	9/32" Hex Bit Socket
310 + 3130	5/16" Hex Bit Socket
312 + 3134	3/8" Hex Bit Socket
314 + 3138	7/16" Hex Bit Socket
316 + 3142	1/2" Hex Bit Socket

Socket Holder
 630 g CODE : 003120
 36 Sets / 24 Kgs / 0.73 CUFT

BS-320HSX 20 Piece SAE Hex Bit Socket Set

Item No.	Description
3/8" Dr. SAE Hex Bit Socket 50mmL:	
308 + 3108	1/8" Hex Bit Socket
308 + 3110	5/32" Hex Bit Socket
308 + 3112	3/16" Hex Bit Socket
308 + 3114	7/32" Hex Bit Socket
308 + 3116	1/4" Hex Bit Socket
310 + 3128	9/32" Hex Bit Socket
310 + 3130	5/16" Hex Bit Socket
312 + 3134	3/8" Hex Bit Socket
314 + 3138	7/16" Hex Bit Socket
316 + 3142	1/2" Hex Bit Socket
3/8" Dr. SAE Hex Bit Socket 180mmL:	
308 + 3708	1/8" Hex Bit Socket
308 + 3710	5/31" Hex Bit Socket
308 + 3712	3/16" Hex Bit Socket
308 + 3714	7/32" Hex Bit Socket
308 + 3716	1/4" Hex Bit Socket
310 + 3718	9/32" Hex Bit Socket
310 + 3720	5/16" Hex Bit Socket
312 + 3724	3/8" Hex Bit Socket
314 + 3728	7/16" Hex Bit Socket
316 + 3732	1/2" Hex Bit Socket

Blow Case
 2150 g CODE : 010300
 6 Sets / 14 Kgs / 1.21 CUFT

BS-310HSL 10 Piece SAE Hex Bit Socket Set

Item No.	Description
3/8" Dr. SAE Hex Bit Socket 140mmL:	
308 + 3608	1/8" Hex Bit Socket
308 + 3610	5/32" Hex Bit Socket
308 + 3612	3/16" Hex Bit Socket
308 + 3614	7/32" Hex Bit Socket
308 + 3616	1/4" Hex Bit Socket
310 + 3618	9/32" Hex Bit Socket
310 + 3620	5/16" Hex Bit Socket
312 + 3624	3/8" Hex Bit Socket
314 + 3628	7/16" Hex Bit Socket
316 + 3632	1/2" Hex Bit Socket

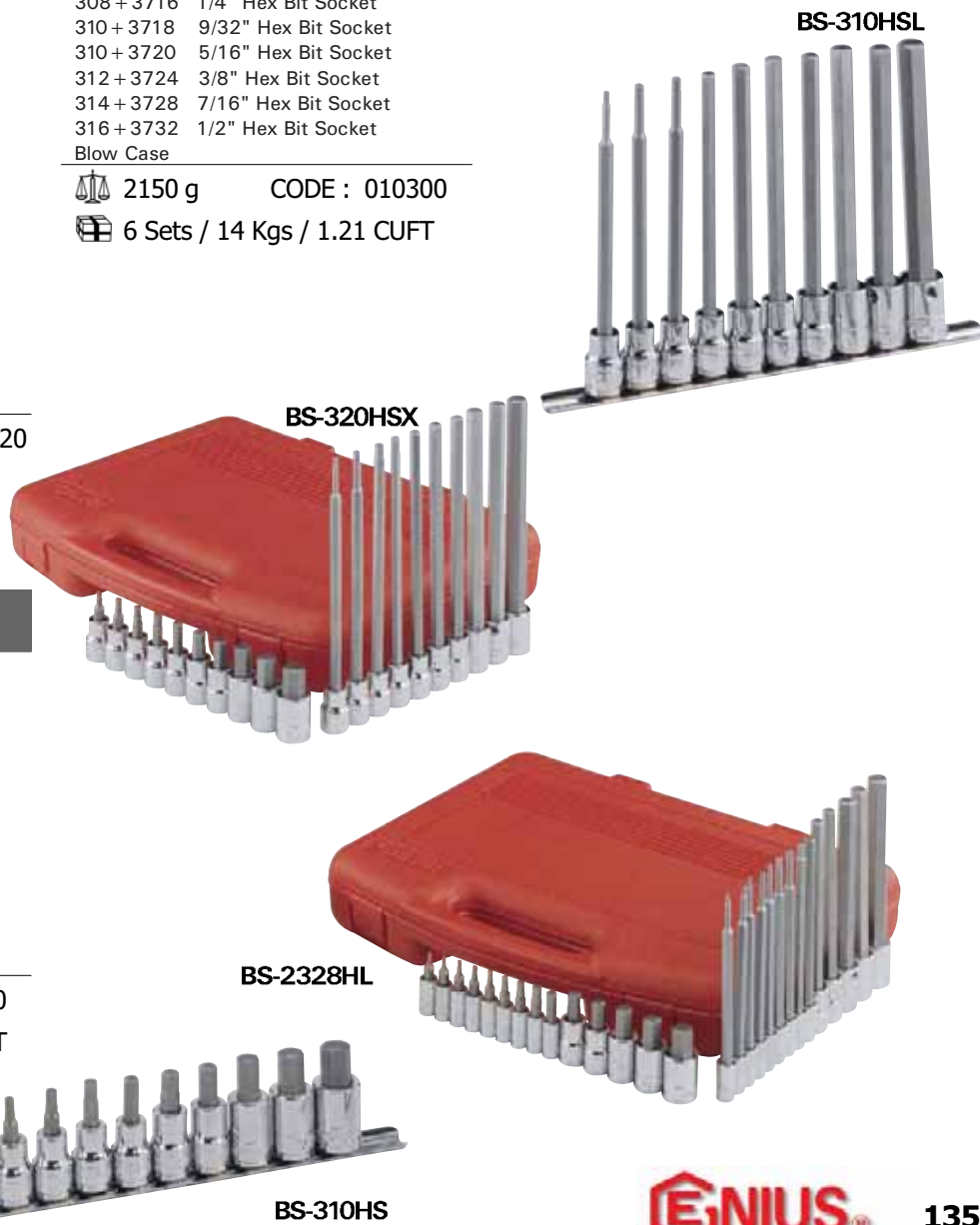

Socket Holder
 1090 g CODE : 006270
 20 Sets / 23 Kgs / 0.82 CUFT



Triple Square Bit Sockets

1/2

Triple Square Bit Sockets



ITEM NO.	Size	Length mm	Weight g	PCS 	G.W. KGS	CUFT 	CODE @
408+8304	M4	80	65	200	14.0	0.59	000460
408+8305	M5	80	65	200	14.0	0.59	000460
408+8306	M6	80	70	200	15.0	0.59	000460
410+8308	M8	80	80	200	17.0	0.59	000500
440+8310	M10	80	110	200	23.0	0.59	000580
442+8312	M12	80	140	150	22.0	0.52	000640
444+8314	M14	80	160	150	25.0	0.52	000700
446+8316	M16	80	200	100	21.0	0.34	000800
408+8504	M4	110	75	200	16.0	0.59	000600
408+8505	M5	110	75	200	16.0	0.59	000600
408+8506	M6	110	80	200	17.0	0.59	000600
410+8508	M8	110	90	200	19.0	0.59	000640
440+8510	M10	110	130	200	27.0	0.59	000760
442+8512	M12	110	170	100	18.0	0.62	000900
444+8514	M14	110	210	100	22.0	0.62	001040
446+8516	M16	110	250	100	26.0	0.62	001160
408+8604	M4	150	85	150	14.0	0.52	000640
408+8605	M5	150	85	150	14.0	0.52	000640
408+8606	M6	150	90	150	14.5	0.52	000640
410+8608	M8	150	110	150	17.5	0.52	000740
440+8610	M10	150	150	150	23.5	0.52	000960
442+8612	M12	150	210	100	22.0	0.62	001110
444+8614	M14	150	260	100	27.0	0.62	001260
446+8616	M16	150	320	80	27.0	0.44	001440
408+8704	M4	190	100	100	10.5	0.62	000720
408+8705	M5	190	100	100	10.5	0.62	000720
408+8706	M6	190	100	100	10.5	0.62	000720
410+8708	M8	190	120	100	12.5	0.62	000840
440+8710	M10	190	170	100	17.5	0.62	001060
442+8712	M12	190	230	80	19.0	0.44	001240
444+8714	M14	190	275	50	14.5	0.62	001410
446+8716	M16	190	390	50	20.0	0.62	001620
408+8806	M6	230	110	100	12.0	0.62	000790
410+8808	M8	230	140	100	15.0	0.62	000940
440+8810	M10	230	210	100	22.0	0.62	001160
442+8812	M12	230	280	80	23.5	0.44	001360
444+8814	M14	230	340	50	18.0	0.62	001560
446+8816	M16	230	430	50	22.5	0.62	001790



BS-3416M 16 Piece Triple Square Bit Socket Set

Item No.	Description	Item No.	Description
3/8" Dr. Triple Square Bit Socket 50mmL:			
308+8104	M4 Triple Square Bit Socket	442+8312	M12 Triple Square Bit Socket
308+8105	M5 Triple Square Bit Socket	444+8314	M14 Triple Square Bit Socket
308+8106	M6 Triple Square Bit Socket	446+8316	M16 Triple Square Bit Socket
1/2" Dr. Triple Square Bit Socket 140mmL:			
308+8604	M4 Triple Square Bit Socket	410+8608	M8 Triple Square Bit Socket
308+8605	M5 Triple Square Bit Socket	440+8610	M10 Triple Square Bit Socket
308+8606	M6 Triple Square Bit Socket	442+8612	M12 Triple Square Bit Socket
1/2" Dr. Triple Square Bit Socket 80mmL:			
410+8308	M8 Triple Square Bit Socket	444+8614	M14 Triple Square Bit Socket
440+8310	M10 Triple Square Bit Socket	446+8616	M16 Triple Square Bit Socket
Blow Case			

BS-3416M

 2305 g  5 Sets / 12 Kgs / 0.93 CUFT CODE : 010070

Bit Socket Sets

TX-2353 53 Piece 1/4" & 3/8" Dr. Complete Bit Socket Set

Item No.	Description	Item No.	Description	Item No.	Description	
1/4" Dr. Metric Hex Bit Socket 45mmL:			1/4" Dr. Slotted Bit Socket 45mmL:			
208 + 2122	2mm Hex Bit Socket	308 + 3116	1/4" Hex Bit Socket	208 + 1130	0.5X3.0 Slotted Bit Socket	
208 + 2125	2.5mm Hex Bit Socket	310 + 3128	9/32" Hex Bit Socket	208 + 1140	0.6X4.0 Slotted Bit Socket	
208 + 2133	3mm Hex Bit Socket	310 + 3130	5/16" Hex Bit Socket	3/8" Dr. Slotted Bit Socket 50mmL:		
208 + 2134	4mm Hex Bit Socket	312 + 3134	3/8" Hex Bit Socket	308 + 1150	0.8X5.0 Slotted Bit Socket	
1/4" Dr. SAE Hex Bit Socket 45mmL:			308 + 1160 1.0X6.0 Slotted Bit Socket			
208 + 3104	1/16" Hex Bit Socket	314 + 3138	7/16" Hex Bit Socket	310 + 1280	1.2X8.0 Slotted Bit Socket	
208 + 3105	5/64" Hex Bit Socket	316 + 3142	1/2" Hex Bit Socket	1/4" Dr. Philips Bit Socket 45mmL:		
208 + 3106	3/32" Hex Bit Socket	1/4" Dr. Star Bit Socket 45mmL:			208 + 1101	#1 Philips Bit Socket
208 + 3107	7/64" Hex Bit Socket	208 + 6106	T-6 Star Bit Socket	208 + 1102	#2 Philips Bit Socket	
208 + 3108	1/8" Hex Bit Socket	208 + 6107	T-7 Star Bit Socket	3/8" Dr. Philips Bit Socket 50mmL:		
208 + 3110	5/32" Hex Bit Socket	208 + 6108	T-8 Star Bit Socket	308 + 1103	#3 Philips Bit Socket	
3/8" Dr. Metric Hex Bit Socket 50mmL:			208 + 6109	T-9 Star Bit Socket	310 + 1124	#4 Philips Bit Socket
308 + 2135	5mm Hex Bit Socket	208 + 6110	T-10 Star Bit Socket	3/8" Dr. Triple Square Bit Socket 50mmL:		
308 + 2136	6mm Hex Bit Socket	208 + 6115	T-15 Star Bit Socket	308 + 8104	M4 Triple Square Bit Socket	
310 + 2147	7mm Hex Bit Socket	3/8" Dr. Star Bit Socket 50mmL:			308 + 8105	M5 Triple Square Bit Socket
310 + 2148	8mm Hex Bit Socket	308 + 6120	T-20 Star Bit Socket	308 + 8106	M6 Triple Square Bit Socket	
340 + 2150	10mm Hex Bit Socket	308 + 6125	T-25 Star Bit Socket	310 + 8108	M8 Triple Square Bit Socket	
342 + 2152	12mm Hex Bit Socket	308 + 6127	T-27 Star Bit Socket	340 + 8110	M10 Triple Square Bit Socket	
3/8" Dr. SAE Hex Bit Socket 50mmL:			308 + 6130	T-30 Star Bit Socket	342 + 8112	M12 Triple Square Bit Socket
308 + 3112	3/16" Hex Bit Socket	308 + 6140	T-40 Star Bit Socket	Plastic Tray		
308 + 3114	7/32" Hex Bit Socket	310 + 6245	T-45 Star Bit Socket			
		310 + 6250	T-50 Star Bit Socket			
		340 + 6255	T-55 Star Bit Socket			



2500 g



5 Sets / 13.5 Kgs / 0.93 CUFT

CODE : 013580

TX-2353



TH-3416

TH-3416 16 Piece 3/8" & 1/2" Dr. Auto Repair Bit Socket Set

Item No.	Description
3/8" Dr. Special Head Bit Socket:	
308 + 2336	6mm Hex Bit Socket 70mmL
308 + 2536	6mm Hex Bit Socket 105mmL
310 + 2547	7mm Hex Bit Socket 105mmL
310 + 2548	8mm Hex Bit Socket 105mmL
310 + 8508	M8 Triple Square Bit Socket 105mmL
340 + 8610	M10 Triple Square Bit Socket 140mmL
342 + 8612	M12 Triple Square Bit Socket 140mmL
1/2" Dr. Special Head Bit Socket:	
410 + 2785	5mm Hex Bit Socket 180mmL
410 + 2676	6mm Hex Bit Socket 160mmL
410 + 2896	6mm Hex Bit Socket 250mmL
410 + 2568	8mm Hex Bit Socket 120mmL
410 + 2898	8mm Hex Bit Socket 240mmL
440 + 2570	10mm Hex Bit Socket 140mmL
442 + 2172	12mm Hex Bit Socket 60mmL
447 + 2177	17mm Hex Bit Socket 60mmL
440 + 6555	T55 Star Type Bit Socket 105mmL
Blow Case	





2400 g

CODE : 010460



6 Sets / 15.5 Kgs / 1.21 CUFT

Slotted Screwdriver Bits

ITEM NO.	Size mm	Hex Shank	Length mm	Weight g	PCS 	G.W. KGS	CUFT 	CODE @
1130	0.5 x 3.0	1/4"	30	8	600	6.0	0.30	000055
1140	0.6 x 4.0	1/4"	30	8	600	6.0	0.30	000055
1150	0.8 x 5.0	1/4"	30	8	600	6.0	0.30	000055
1155	0.8 x 5.5	1/4"	30	8	600	6.0	0.30	000055
1160	1.0 x 6.0	1/4"	30	8	600	6.0	0.30	000055
1165	1.0 x 6.5	1/4"	30	8	600	6.0	0.30	000055
1170	1.2 x 7.0	1/4"	30	8	600	6.0	0.30	000055
1250	0.8 x 5.0	5/16"	30	11	600	8.0	0.30	000092
1255	0.8 x 5.5	5/16"	30	11	600	8.0	0.30	000092
1260	1.0 x 6.0	5/16"	30	11	600	8.0	0.30	000092
1265	1.0 x 6.5	5/16"	30	11	600	8.0	0.30	000092
1280	1.2 x 8.0	5/16"	30	11	600	8.0	0.30	000092
1290	1.6 x 9.0	5/16"	30	11	600	8.0	0.30	000092
1330	0.5 x 3.0	1/4"	56	15	600	10.0	0.30	000120
1340	0.6 x 4.0	1/4"	56	15	600	10.0	0.30	000120
1350	0.8 x 5.0	1/4"	56	15	600	10.0	0.30	000120
1360	1.0 x 6.0	1/4"	56	15	600	10.0	0.30	000120
1470	1.2 x 7.0	5/16"	56	20	600	13.0	0.30	000160
1480	1.2 x 8.0	5/16"	56	20	600	13.0	0.30	000160
1490	1.6 x 9.0	5/16"	56	20	600	13.0	0.30	000160
1492	2.0 x 12.0	10mm	56	37	300	12.5	0.52	000220
1494	2.5 x 14.0	12mm	56	54	300	17.5	0.52	000280
1496	2.5 x 16.0	14mm	56	66	300	21.0	0.52	000340
1465	1.2 x 6.5	1/4"	75	20	400	11.0	0.59	000230
1530	0.5 x 3.0	1/4"	88	24	400	11.0	0.59	000260
1540	0.6 x 4.0	1/4"	88	24	400	11.0	0.59	000260
1550	0.8 x 5.0	1/4"	88	24	400	11.0	0.59	000260
1560	1.0 x 6.0	1/4"	88	24	400	11.0	0.59	000260
1580	1.2 x 8.0	5/16"	88	35	400	15.0	0.59	000300
1590	1.6 x 9.0	5/16"	88	35	400	15.0	0.59	000300
1592	2.0 x 12.0	10mm	88	57	200	12.5	0.44	000400
1594	2.5 x 14.0	12mm	88	84	200	18.0	0.44	000540
1596	2.5 x 16.0	14mm	88	102	200	21.5	0.44	000680
1630	0.5 x 3.0	1/4"	125	34	300	11.5	0.52	000300
1640	0.6 x 4.0	1/4"	125	34	300	11.5	0.52	000300
1650	0.8 x 5.0	1/4"	125	34	300	11.5	0.52	000300
1660	1.0 x 6.0	1/4"	125	34	300	11.5	0.52	000300
1680	1.2 x 8.0	5/16"	125	50	300	16.0	0.52	000400
1690	1.6 x 9.0	5/16"	125	50	300	16.0	0.52	000400
1692	2.0 x 12.0	10mm	125	81	150	13.5	0.52	000600
1694	2.5 x 14.0	12mm	125	120	150	19.0	0.52	000750
1696	2.5 x 16.0	14mm	125	145	150	23.0	0.52	000900
1740	0.6 x 4.0	1/4"	160	45	200	9.5	0.62	000380
1750	0.8 x 5.0	1/4"	160	45	200	9.5	0.62	000380
1760	1.0 x 6.0	1/4"	160	45	200	9.5	0.62	000380
1780	1.2 x 8.0	5/16"	160	65	200	13.5	0.62	000500
1790	1.6 x 9.0	5/16"	160	65	200	13.5	0.62	000500
1792	2.0 x 12.0	10mm	160	105	100	11.0	0.44	000700
1794	2.5 x 14.0	12mm	160	155	100	16.0	0.44	000880
1796	2.5 x 16.0	14mm	160	190	100	19.5	0.44	001050
1965	1.2 x 6.5	1/4"	175	50	200	12.0	0.62	000420



Screwdriver Bits





Slotted Screwdriver Bit

ITEM NO.	Size mm	Hex Shank	Length mm	Weight g	PCS 	G.W. KGS	CUFT 	CODE @
1840	0.6 x 4.0	1/4"	200	55	200	12.0	0.62	000450
1850	0.8 x 5.0	1/4"	200	55	200	12.0	0.62	000450
1860	1.0 x 6.0	1/4"	200	55	200	12.0	0.62	000450
1880	1.2 x 8.0	5/16"	200	80	200	17.0	0.62	000600
1890	1.6 x 9.0	5/16"	200	80	200	17.0	0.62	000600
1892	2.0 x 12.0	10mm	200	130	100	14.0	0.44	000800
1894	2.5 x 14.0	12mm	200	194	100	20.5	0.44	001000
1896	2.5 x 16.0	14mm	200	234	100	24.5	0.44	001200
1980	1.2 x 8.0	5/16"	260	100	100	11.0	0.44	000820
1990	1.6 x 10.0	10mm	285	180	100	19.0	0.44	001140

Philips Screwdriver Bits

ITEM NO.	Size	Hex Shank	Length mm	Weight g	PCS 	G.W. KGS	CUFT 	CODE @
1100	#0	1/4"	30	8	600	5.8	0.30	000055
1101	#1	1/4"	30	8	600	5.8	0.30	000055
1102	#2	1/4"	30	8	600	5.8	0.30	000055
1103	#3	1/4"	30	8	600	5.8	0.30	000055
1121	#1	5/16"	30	11	600	7.6	0.30	000092
1122	#2	5/16"	30	11	600	7.6	0.30	000092
1123	#3	5/16"	30	11	600	7.6	0.30	000092
1124	#4	5/16"	30	11	600	7.6	0.30	000092
1301	#1	1/4"	56	15	600	10.0	0.30	000120
1302	#2	1/4"	56	15	600	10.0	0.30	000120
1303	#3	1/4"	56	15	600	10.0	0.30	000120
1402	#2	5/16"	56	20	600	13.0	0.30	000160
1403	#3	5/16"	56	20	600	13.0	0.30	000160
1404	#4	5/16"	56	20	600	13.0	0.30	000160
1501	#1	1/4"	88	25	360	10.0	0.30	000260
1502	#2	1/4"	88	25	360	10.0	0.30	000260
1503	#3	1/4"	88	25	360	10.0	0.30	000260
1504	#4	5/16"	88	40	300	13.0	0.30	000300
1601	#1	1/4"	125	35	300	11.5	0.52	000300
1602	#2	1/4"	125	35	300	11.5	0.52	000300
1603	#3	1/4"	125	35	300	11.5	0.52	000300
1604	#4	5/16"	125	55	300	17.5	0.52	000400
1701	#1	1/4"	160	45	200	9.5	0.62	000380
1702	#2	1/4"	160	45	200	9.5	0.62	000380
1703	#3	1/4"	160	45	200	9.5	0.62	000380
1704	#4	5/16"	160	70	200	14.5	0.62	000500
1801	#1	1/4"	200	55	200	12.0	0.62	000450
1802	#2	1/4"	200	55	200	12.0	0.62	000450
1803	#3	1/4"	200	55	200	12.0	0.62	000450
1804	#4	5/16"	200	90	200	19.0	0.62	000600
1902	#2	1/4"	275	75	100	8.5	0.44	000620
1903	#3	5/16"	285	130	100	14.0	0.44	000950

Metric Hex Screwdriver Bits

ITEM NO.	Size mm	Hex Shank	Length mm	Weight g	PCS 	G.W. KGS	CUFT 	CODE @
2122	2	1/4"	30	8	600	6.0	0.30	000055
2125	2.5	1/4"	30	8	600	6.0	0.30	000055
2133	3	1/4"	30	8	600	6.0	0.30	000055
2134	4	1/4"	30	8	600	6.0	0.30	000055
2135	5	1/4"	30	8	600	6.0	0.30	000055
2136	6	1/4"	30	8	600	6.0	0.30	000055
2143	3	5/16"	30	11	600	8.0	0.30	000092
2144	4	5/16"	30	11	600	8.0	0.30	000092
2145	5	5/16"	30	11	600	8.0	0.30	000092
2146	6	5/16"	30	11	600	8.0	0.30	000092
2147	7	5/16"	30	11	600	8.0	0.30	000092
2148	8	5/16"	30	11	600	8.0	0.30	000092
2149	9	9mm	30	18	300	6.5	0.30	000150
2150	10	10mm	30	20	300	7.0	0.30	000150
2151	11	11mm	30	25	300	8.5	0.30	000195
2152	12	12mm	30	29	300	10.0	0.30	000195

2322	2	1/4"	56	15	600	10.0	0.30	000120
2325	2.5	1/4"	56	15	600	10.0	0.30	000120
2333	3	1/4"	56	15	600	10.0	0.30	000120
2334	4	1/4"	56	15	600	10.0	0.30	000120
2335	5	1/4"	56	15	600	10.0	0.30	000120
2336	6	1/4"	56	15	600	10.0	0.30	000120
2347	7	5/16"	56	20	600	13.0	0.30	000160
2348	8	5/16"	56	20	600	13.0	0.30	000160
2349	9	9mm	56	30	300	10.0	0.52	000220
2350	10	10mm	56	37	300	12.5	0.52	000220
2351	11	11mm	56	46	300	15.0	0.52	000280
2352	12	12mm	56	54	300	17.5	0.52	000280
2353	13	13mm	56	60	300	19.0	0.52	000310
2354	14	14mm	56	66	300	21.0	0.52	000340
2356	16	16mm	56	102	150	16.5	0.52	000410
2357	17	17mm	56	110	150	17.5	0.52	000480
2359	19	19mm	56	120	150	19.0	0.52	000540

2522	2	1/4"	88	24	400	11.0	0.59	000260
2525	2.5	1/4"	88	24	400	11.0	0.59	000260
2533	3	1/4"	88	24	400	11.0	0.59	000260
2534	4	1/4"	88	24	400	11.0	0.59	000260
2535	5	1/4"	88	24	400	11.0	0.59	000260
2536	6	1/4"	88	24	400	11.0	0.59	000260
2547	7	5/16"	88	35	400	15.0	0.59	000300
2548	8	5/16"	88	35	400	15.0	0.59	000300
2549	9	9mm	88	50	200	11.0	0.44	000400
2550	10	10mm	88	57	200	12.5	0.44	000400
2551	11	11mm	88	70	200	15.0	0.44	000540
2552	12	12mm	88	85	200	18.0	0.44	000540
2553	13	13mm	88	90	200	19.0	0.44	000680
2554	14	14mm	88	100	200	21.0	0.44	000680
2556	16	16mm	88	160	100	17.0	0.44	000770
2557	17	17mm	88	170	100	18.0	0.44	000820
2559	19	19mm	88	190	100	20.0	0.44	000920



2622	2	1/4"	125	34	300	11.5	0.52	000300
2625	2.5	1/4"	125	34	300	11.5	0.52	000300
2633	3	1/4"	125	34	300	11.5	0.52	000300
2634	4	1/4"	125	34	300	11.5	0.52	000300
2635	5	1/4"	125	34	300	11.5	0.52	000300
2636	6	1/4"	125	34	300	11.5	0.52	000300
2647	7	5/16"	125	50	300	16.0	0.52	000400
2648	8	5/16"	125	50	300	16.0	0.52	000400
2649	9	9mm	125	70	150	11.5	0.52	000600
2650	10	10mm	125	81	150	13.5	0.52	000600



Screwdriver Bits



Metric Hex Screwdriver Bits

ITEM NO.	Size mm	Hex Shank	Length mm	Weight g	PCS 	G.W. KGS	CUFT 	CODE @
2651	11	11mm	125	100	150	16.0	0.52	000750
2652	12	12mm	125	120	150	19.0	0.52	000750
2653	13	13mm	125	130	150	20.5	0.52	000900
2654	14	14mm	125	145	150	23.0	0.52	000900
2656	16	16mm	125	230	80	19.5	0.44	001050
2657	17	17mm	125	240	80	20.5	0.44	001160
2659	19	19mm	125	270	80	23.0	0.44	001310

2722	2	1/4"	160	45	200	9.5	0.62	000380
2725	2.5	1/4"	160	45	200	9.5	0.62	000380
2733	3	1/4"	160	45	200	9.5	0.62	000380
2734	4	1/4"	160	45	200	9.5	0.62	000380
2735	5	1/4"	160	45	200	9.5	0.62	000380
2736	6	1/4"	160	45	200	9.5	0.62	000380
2747	7	5/16"	160	65	200	13.5	0.62	000500
2748	8	5/16"	160	65	200	13.5	0.62	000500
2749	9	9mm	160	90	100	9.5	0.44	000700
2750	10	10mm	160	105	100	11.0	0.44	000700
2751	11	11mm	160	130	100	13.5	0.44	000880
2752	12	12mm	160	155	100	16.0	0.44	000880
2753	13	13mm	160	170	100	17.5	0.44	001050
2754	14	14mm	160	190	100	19.5	0.44	001050
2756	16	16mm	160	300	60	18.5	0.44	001230
2757	17	17mm	160	310	60	19.0	0.44	001340
2759	19	19mm	160	350	60	21.5	0.44	001520



2833	3	1/4"	200	55	200	12.0	0.62	000450
2834	4	1/4"	200	55	200	12.0	0.62	000450
2835	5	1/4"	200	55	200	12.0	0.62	000450
2836	6	1/4"	200	55	200	12.0	0.62	000450
2847	7	5/16"	200	80	200	17.0	0.62	000600
2848	8	5/16"	200	80	200	17.0	0.62	000600
2849	9	9mm	200	110	100	12.0	0.44	000800
2850	10	10mm	200	130	100	14.0	0.44	000800
2851	11	11mm	200	160	100	17.0	0.44	001000
2852	12	12mm	200	194	100	20.5	0.44	001000
2853	13	13mm	200	210	100	22.0	0.44	001200
2854	14	14mm	200	234	100	24.5	0.44	001200
2856	16	16mm	200	365	60	23.0	0.44	001400
2857	17	17mm	200	388	60	24.5	0.44	001520
2859	19	19mm	200	434	60	27.0	0.44	001720

SAE Hex Screwdriver Bits

ITEM NO.	Size Inch	Hex Shank	Length mm	Weight g	PCS 	G.W. KGS	CUFT 	CODE @
3104	1/16	1/4"	30	8	600	6.0	0.30	000055
3105	5/64	1/4"	30	8	600	6.0	0.30	000055
3106	3/32	1/4"	30	8	600	6.0	0.30	000055
3107	7/64	1/4"	30	8	600	6.0	0.30	000055
3108	1/8	1/4"	30	8	600	6.0	0.30	000055
3110	5/32	1/4"	30	8	600	6.0	0.30	000055
3112	3/16	1/4"	30	8	600	6.0	0.30	000055
3114	7/32	1/4"	30	8	600	6.0	0.30	000055
3116	1/4	1/4"	30	8	600	6.0	0.30	000055
3118	1/8	5/16"	30	11	600	8.0	0.30	000092
3120	5/32	5/16"	30	11	600	8.0	0.30	000092
3122	3/16	5/16"	30	11	600	8.0	0.30	000092
3124	7/32	5/16"	30	11	600	8.0	0.30	000092
3126	1/4	5/16"	30	11	600	8.0	0.30	000092
3128	9/32	5/16"	30	11	600	8.0	0.30	000092
3130	5/16	5/16"	30	11	600	8.0	0.30	000092

Screwdriver Bits



SAE Hex Screwdriver Bits

ITEM NO.	Size Inch	Hex Shank	Length mm	Weight g	PCS 	G.W. KGS	CUFT 	CODE @
3134	3/8	3/8"	30	20	300	7.0	0.30	000150
3138	7/16	7/16"	30	25	300	8.5	0.30	000195
3142	1/2	1/2"	30	30	300	10.0	0.30	000240
3304	1/16	1/4"	56	15	600	10.0	0.30	000120
3305	5/64	1/4"	56	15	600	10.0	0.30	000120
3306	3/32	1/4"	56	15	600	10.0	0.30	000120
3307	7/64	1/4"	56	15	600	10.0	0.30	000120
3308	1/8	1/4"	56	15	600	10.0	0.30	000120
3310	5/32	1/4"	56	15	600	10.0	0.30	000120
3312	3/16	1/4"	56	15	600	10.0	0.30	000120
3314	7/32	1/4"	56	15	600	10.0	0.30	000120
3316	1/4	1/4"	56	15	600	10.0	0.30	000120
3318	9/32	5/16"	56	20	600	13.0	0.30	000160
3320	5/16	5/16"	56	20	600	13.0	0.30	000160
3324	3/8	3/8"	56	35	300	11.5	0.52	000220
3328	7/16	7/16"	56	46	300	15.0	0.52	000280
3332	1/2	1/2"	56	55	300	17.5	0.52	000310
3336	9/16	9/16"	56	67	300	21.0	0.52	000340
3340	5/8	5/8"	56	100	150	16.0	0.52	000410
3344	11/16	11/16"	56	110	150	17.5	0.52	000480
3348	3/4	3/4"	56	120	150	19.0	0.52	000540
3504	1/16	1/4"	88	24	400	11.0	0.59	000260
3505	5/64	1/4"	88	24	400	11.0	0.59	000260
3506	3/32	1/4"	88	24	400	11.0	0.59	000260
3507	7/64	1/4"	88	24	400	11.0	0.59	000260
3508	1/8	1/4"	88	24	400	11.0	0.59	000260
3510	5/32	1/4"	88	24	400	11.0	0.59	000260
3512	3/16	1/4"	88	24	400	11.0	0.59	000260
3514	7/32	1/4"	88	24	400	11.0	0.59	000260
3516	1/4	1/4"	88	24	400	11.0	0.59	000260
3518	9/32	5/16"	88	35	400	15.0	0.59	000300
3520	5/16	5/16"	88	35	400	15.0	0.59	000300
3524	3/8	3/8"	88	55	200	12.0	0.44	000400
3528	7/16	7/16"	88	70	200	15.0	0.44	000540
3532	1/2	1/2"	88	90	200	19.0	0.44	000680
3536	9/16	9/16"	88	105	200	22.0	0.44	000740
3540	5/8	5/8"	88	158	100	17.0	0.44	000770
3544	11/16	11/16"	88	173	100	18.5	0.44	000820
3548	3/4	3/4"	88	190	100	20.0	0.44	000920
3604	1/16	1/4"	125	34	300	11.5	0.52	000300
3605	5/64	1/4"	125	34	300	11.5	0.52	000300
3606	3/32	1/4"	125	34	300	11.5	0.52	000300
3607	7/64	1/4"	125	34	300	11.5	0.52	000300
3608	1/8	1/4"	125	34	300	11.5	0.52	000300
3610	5/32	1/4"	125	34	300	11.5	0.52	000300
3612	3/16	1/4"	125	34	300	11.5	0.52	000300
3614	7/32	1/4"	125	34	300	11.5	0.52	000300
3616	1/4	1/4"	125	34	300	11.5	0.52	000300
3618	9/32	5/16"	125	50	300	16.0	0.52	000400
3620	5/16	5/16"	125	50	300	16.0	0.52	000400
3624	3/8	3/8"	125	78	150	13.0	0.52	000600
3628	7/16	7/16"	125	100	150	16.0	0.52	000750
3632	1/2	1/2"	125	127	150	20.0	0.52	000900
3636	9/16	9/16"	125	148	150	23.5	0.52	000980
3640	5/8	5/8"	125	225	80	19.0	0.44	001050
3644	11/16	11/16"	125	247	80	21.0	0.44	001160
3648	3/4	3/4"	125	270	80	23.0	0.44	001310



Screwdriver Bits

SAE Hex Screwdriver Bits

ITEM NO.	Size Inch	Hex Shank	Length mm	Weight g	PCS 	G.W. KGS	CUFT 	CODE @
3704	1/16	1/4"	160	45	200	9.5	0.62	000380
3705	5/64	1/4"	160	45	200	9.5	0.62	000380
3706	3/32	1/4"	160	45	200	9.5	0.62	000380
3707	7/64	1/4"	160	45	200	9.5	0.62	000380
3708	1/8	1/4"	160	45	200	9.5	0.62	000380
3710	5/32	1/4"	160	45	200	9.5	0.62	000380
3712	3/16	1/4"	160	45	200	9.5	0.62	000380
3714	7/32	1/4"	160	45	200	9.5	0.62	000380
3716	1/4	1/4"	160	45	200	9.5	0.62	000380
3718	9/32	5/16"	160	65	200	13.5	0.62	000500
3720	5/16	5/16"	160	65	200	13.5	0.62	000500
3724	3/8	3/8"	160	100	100	10.5	0.44	000700
3728	7/16	7/16"	160	130	100	13.5	0.44	000880
3732	1/2	1/2"	160	165	100	17.0	0.44	001050
3736	9/16	9/16"	160	190	100	19.5	0.44	001140
3740	5/8	5/8"	160	290	60	18.0	0.44	001230
3744	11/16	11/16"	160	320	60	19.5	0.44	001340
3748	3/4	3/4"	160	350	60	21.5	0.44	001520
3808	1/8	1/4"	200	55	200	12.0	0.62	000450
3810	5/32	1/4"	200	55	200	12.0	0.62	000450
3812	3/16	1/4"	200	55	200	12.0	0.62	000450
3814	7/32	1/4"	200	55	200	12.0	0.62	000450
3816	1/4	1/4"	200	55	200	12.0	0.62	000450
3818	9/32	5/16"	200	80	200	17.0	0.62	000600
3820	5/16	5/16"	200	80	200	17.0	0.62	000600
3824	3/8	3/8"	200	125	100	13.5	0.44	000800
3828	7/16	7/16"	200	163	100	17.5	0.44	001000
3832	1/2	1/2"	200	205	100	21.5	0.44	001200
3836	9/16	9/16"	200	240	100	25.0	0.44	001300
3840	5/8	5/8"	200	362	60	23.0	0.44	001400
3844	11/16	11/16"	200	400	60	25.0	0.44	001520
3848	3/4	3/4"	200	434	60	27.0	0.44	001720





Metric Wobble Hex Screwdriver Bits

ITEM NO.	Size mm	Hex Shank	Length mm	Weight g	PCS 	G.W. KGS	CUFT 	CODE @
4133	3	1/4"	30	8	600	6.0	0.30	000085
4134	4	1/4"	30	8	600	6.0	0.30	000085
4135	5	1/4"	30	8	600	6.0	0.30	000085
4136	6	1/4"	30	8	600	6.0	0.30	000085
4147	7	5/16"	30	11	600	8.0	0.30	000125
4148	8	5/16"	30	11	600	8.0	0.30	000125
4149	9	9mm	30	18	300	6.5	0.30	000180
4150	10	10mm	30	20	300	7.0	0.30	000180
4333	3	1/4"	56	15	600	10.0	0.30	000150
4334	4	1/4"	56	15	600	10.0	0.30	000150
4335	5	1/4"	56	15	600	10.0	0.30	000150
4336	6	1/4"	56	15	600	10.0	0.30	000150
4347	7	5/16"	56	20	600	13.0	0.30	000190
4348	8	5/16"	56	20	600	13.0	0.30	000190
4349	9	9mm	56	30	300	10.0	0.52	000250
4350	10	10mm	56	37	300	12.5	0.52	000250
4533	3	1/4"	88	24	400	11.0	0.59	000300
4534	4	1/4"	88	24	400	11.0	0.59	000300
4535	5	1/4"	88	24	400	11.0	0.59	000300
4536	6	1/4"	88	24	400	11.0	0.59	000300
4547	7	5/16"	88	35	400	15.0	0.59	000340
4548	8	5/16"	88	35	400	15.0	0.59	000340
4549	9	9mm	88	50	200	11.0	0.44	000440
4550	10	10mm	88	60	200	13.0	0.44	000440
4633	3	1/4"	125	34	300	11.5	0.52	000350
4634	4	1/4"	125	34	300	11.5	0.52	000350
4635	5	1/4"	125	34	300	11.5	0.52	000350
4636	6	1/4"	125	34	300	11.5	0.52	000350
4647	7	5/16"	125	50	300	16.0	0.52	000450
4648	8	5/16"	125	50	300	16.0	0.52	000450
4649	9	9mm	125	70	150	11.5	0.52	000650
4650	10	10mm	125	80	150	13.0	0.52	000650
4733	3	1/4"	160	45	200	9.5	0.62	000430
4734	4	1/4"	160	45	200	9.5	0.62	000430
4735	5	1/4"	160	45	200	9.5	0.62	000430
4736	6	1/4"	160	45	200	9.5	0.62	000430
4747	7	5/16"	160	65	200	13.5	0.62	000560
4748	8	5/16"	160	65	200	13.5	0.62	000560
4749	9	9mm	160	90	100	9.5	0.44	000760
4750	10	10mm	160	105	100	11.0	0.44	000760
4833	3	1/4"	200	55	200	12.0	0.62	000510
4834	4	1/4"	200	55	200	12.0	0.62	000510
4835	5	1/4"	200	55	200	12.0	0.62	000510
4836	6	1/4"	200	55	200	12.0	0.62	000510
4847	7	5/16"	200	80	200	17.0	0.62	000660
4848	8	5/16"	200	80	200	17.0	0.62	000660
4849	9	9mm	200	110	100	12.0	0.44	000860
4850	10	10mm	200	130	100	14.0	0.44	000860



Screwdriver Bits



SAE Wobble Hex Screwdriver Bits

ITEM NO.	Size Inch	Hex Shank	Length mm	Weight g	PCS 	G.W. KGS	CUFT 	CODE @
5108	1/8	1/4"	30	8	600	6.0	0.30	000085
5110	5/32	1/4"	30	8	600	6.0	0.30	000085
5112	3/16	1/4"	30	8	600	6.0	0.30	000085
5114	7/32	1/4"	30	8	600	6.0	0.30	000085
5116	1/4	1/4"	30	8	600	6.0	0.30	000085
5118	9/32	5/16"	30	11	600	8.0	0.30	000125
5120	5/16	5/16"	30	11	600	8.0	0.30	000125
5124	3/8	3/8"	30	20	300	7.0	0.30	000180
5308	1/8	1/4"	56	15	600	10.0	0.30	000150
5310	5/32	1/4"	56	15	600	10.0	0.30	000150
5312	3/16	1/4"	56	15	600	10.0	0.30	000150
5314	7/32	1/4"	56	15	600	10.0	0.30	000150
5316	1/4	1/4"	56	15	600	10.0	0.30	000150
5318	9/32	5/16"	56	20	600	13.0	0.30	000190
5320	5/16	5/16"	56	20	600	13.0	0.30	000190
5324	3/8	3/8"	56	35	300	11.5	0.52	000250
5508	1/8	1/4"	88	24	400	11.0	0.59	000300
5510	5/32	1/4"	88	24	400	11.0	0.59	000300
5512	3/16	1/4"	88	24	400	11.0	0.59	000300
5514	7/32	1/4"	88	24	400	11.0	0.59	000300
5516	1/4	1/4"	88	24	400	11.0	0.59	000300
5518	9/32	5/16"	88	35	400	15.0	0.59	000340
5520	5/16	5/16"	88	35	400	15.0	0.59	000340
5524	3/8	3/8"	88	55	200	12.0	0.44	000440
5608	1/8	1/4"	125	34	300	11.5	0.52	000350
5610	5/32	1/4"	125	34	300	11.5	0.52	000350
5612	3/16	1/4"	125	34	300	11.5	0.52	000350
5614	7/32	1/4"	125	34	300	11.5	0.52	000350
5616	1/4	1/4"	125	34	300	11.5	0.52	000350
5618	9/32	5/16"	125	50	300	16.0	0.52	000450
5620	5/16	5/16"	125	50	300	16.0	0.52	000450
5624	3/8	3/8"	125	78	150	13.0	0.52	000650
5708	1/8	1/4"	160	45	200	9.5	0.62	000430
5710	5/32	1/4"	160	45	200	9.5	0.62	000430
5712	3/16	1/4"	160	45	200	9.5	0.62	000430
5714	7/32	1/4"	160	45	200	9.5	0.62	000430
5716	1/4	1/4"	160	45	200	9.5	0.62	000430
5718	9/32	5/16"	160	65	200	13.5	0.62	000560
5720	5/16	5/16"	160	65	200	13.5	0.62	000560
5724	3/8	3/8"	160	100	100	10.5	0.44	000760
5808	1/8	1/4"	200	55	200	12.0	0.62	000510
5810	5/32	1/4"	200	55	200	12.0	0.62	000510
5812	3/16	1/4"	200	55	200	12.0	0.62	000510
5814	7/32	1/4"	200	55	200	12.0	0.62	000510
5816	1/4	1/4"	200	55	200	12.0	0.62	000510
5818	9/32	5/16"	200	80	200	17.0	0.62	000660
5820	5/16	5/16"	200	80	200	17.0	0.62	000660
5824	3/8	3/8"	200	125	100	13.5	0.44	000860



Screwdriver Bits

★ Star Screwdriver Bits

ITEM NO.	Size	Hex Shank	Length mm	Weight g	PCS	G.W. KGS	CUFT	CODE @
6106	T-6	1/4"	30	8	600	6.0	0.30	000055
6107	T-7	1/4"	30	8	600	6.0	0.30	000055
6108	T-8	1/4"	30	8	600	6.0	0.30	000055
6109	T-9	1/4"	30	8	600	6.0	0.30	000055
6110	T-10	1/4"	30	8	600	6.0	0.30	000055
6115	T-15	1/4"	30	8	600	6.0	0.30	000055
6120	T-20	1/4"	30	8	600	6.0	0.30	000055
6125	T-25	1/4"	30	8	600	6.0	0.30	000055
6127	T-27	1/4"	30	8	600	6.0	0.30	000055
6130	T-30	1/4"	30	8	600	6.0	0.30	000055
6140	T-40	1/4"	30	8	600	6.0	0.30	000055
6210	T-10	5/16"	30	11	600	8.0	0.30	000092
6215	T-15	5/16"	30	11	600	8.0	0.30	000092
6220	T-20	5/16"	30	11	600	8.0	0.30	000092
6225	T-25	5/16"	30	11	600	8.0	0.30	000092
6227	T-27	5/16"	30	11	600	8.0	0.30	000092
6230	T-30	5/16"	30	11	600	8.0	0.30	000092
6240	T-40	5/16"	30	11	600	8.0	0.30	000092
6245	T-45	5/16"	30	11	600	8.0	0.30	000092
6250	T-50	5/16"	30	11	600	8.0	0.30	000092
6255	T-55	10mm	30	20	300	7.0	0.30	000150
6306	T-6	1/4"	56	15	600	10.0	0.30	000120
6307	T-7	1/4"	56	15	600	10.0	0.30	000120
6308	T-8	1/4"	56	15	600	10.0	0.30	000120
6309	T-9	1/4"	56	15	600	10.0	0.30	000120
6310	T-10	1/4"	56	15	600	10.0	0.30	000120
6315	T-15	1/4"	56	15	600	10.0	0.30	000120
6320	T-20	1/4"	56	15	600	10.0	0.30	000120
6325	T-25	1/4"	56	15	600	10.0	0.30	000120
6327	T-27	1/4"	56	15	600	10.0	0.30	000120
6330	T-30	1/4"	56	15	600	10.0	0.30	000120
6340	T-40	1/4"	56	15	600	10.0	0.30	000120
6345	T-45	5/16"	56	20	600	13.0	0.30	000160
6350	T-50	5/16"	56	20	600	13.0	0.30	000160
6355	T-55	10mm	56	37	300	12.5	0.52	000220
6360	T-60	12mm	56	54	300	17.5	0.52	000280
6370	T-70	14mm	56	65	300	20.5	0.52	000340
6506	T-6	1/4"	88	24	400	11.0	0.59	000260
6507	T-7	1/4"	88	24	400	11.0	0.59	000260
6508	T-8	1/4"	88	24	400	11.0	0.59	000260
6509	T-9	1/4"	88	24	400	11.0	0.59	000260
6510	T-10	1/4"	88	24	400	11.0	0.59	000260
6515	T-15	1/4"	88	24	400	11.0	0.59	000260
6520	T-20	1/4"	88	24	400	11.0	0.59	000260
6525	T-25	1/4"	88	24	400	11.0	0.59	000260
6527	T-27	1/4"	88	24	400	11.0	0.59	000260
6530	T-30	1/4"	88	24	400	11.0	0.59	000260
6540	T-40	1/4"	88	24	400	11.0	0.59	000260
6545	T-45	5/16"	88	35	400	15.0	0.59	000300
6550	T-50	5/16"	88	35	400	15.0	0.59	000300
6555	T-55	10mm	88	57	200	12.5	0.44	000400
6560	T-60	12mm	88	85	200	18.0	0.44	000540
6570	T-70	14mm	88	100	200	21.0	0.44	000680



Screwdriver Bits



★ Star Screwdriver Bits



ITEM NO.	Size	Hex Shank	Length mm	Weight g	PCS	G.W. KGS	CUFT	CODE @
6606	T-6	1/4"	125	34	300	11.5	0.52	000300
6607	T-7	1/4"	125	34	300	11.5	0.52	000300
6608	T-8	1/4"	125	34	300	11.5	0.52	000300
6609	T-9	1/4"	125	34	300	11.5	0.52	000300
6610	T-10	1/4"	125	34	300	11.5	0.52	000300
6615	T-15	1/4"	125	34	300	11.5	0.52	000300
6620	T-20	1/4"	125	34	300	11.5	0.52	000300
6625	T-25	1/4"	125	34	300	11.5	0.52	000300
6627	T-27	1/4"	125	34	300	11.5	0.52	000300
6630	T-30	1/4"	125	34	300	11.5	0.52	000300
6640	T-40	1/4"	125	34	300	11.5	0.52	000300
6645	T-45	5/16"	125	50	300	16.0	0.52	000400
6650	T-50	5/16"	125	50	300	16.0	0.52	000400
6655	T-55	10mm	125	80	150	13.0	0.44	000600
6660	T-60	12mm	125	120	150	19.0	0.44	000750
6670	T-70	14mm	125	145	150	23.0	0.44	000900

6706	T-6	1/4"	160	45	200	9.5	0.62	000380
6707	T-7	1/4"	160	45	200	9.5	0.62	000380
6708	T-8	1/4"	160	45	200	9.5	0.62	000380
6709	T-9	1/4"	160	45	200	9.5	0.62	000380
6710	T-10	1/4"	160	45	200	9.5	0.62	000380
6715	T-15	1/4"	160	45	200	9.5	0.62	000380
6720	T-20	1/4"	160	45	200	9.5	0.62	000380
6725	T-25	1/4"	160	45	200	9.5	0.62	000380
6727	T-27	1/4"	160	45	200	9.5	0.62	000380
6730	T-30	1/4"	160	45	200	9.5	0.62	000380
6740	T-40	1/4"	160	45	200	9.5	0.62	000380
6745	T-45	5/16"	160	65	200	13.5	0.62	000500
6750	T-50	5/16"	160	65	200	13.5	0.62	000500
6755	T-55	10mm	160	105	100	11.0	0.44	000700
6760	T-60	12mm	160	155	100	16.0	0.44	000880
6770	T-70	14mm	160	190	100	19.5	0.44	001050

6806	T-6	1/4"	200	55	200	12.0	0.62	000450
6807	T-7	1/4"	200	55	200	12.0	0.62	000450
6808	T-8	1/4"	200	55	200	12.0	0.62	000450
6809	T-9	1/4"	200	55	200	12.0	0.62	000450
6810	T-10	1/4"	200	55	200	12.0	0.62	000450
6815	T-15	1/4"	200	55	200	12.0	0.62	000450
6820	T-20	1/4"	200	55	200	12.0	0.62	000450
6825	T-25	1/4"	200	55	200	12.0	0.62	000450
6827	T-27	1/4"	200	55	200	12.0	0.62	000450
6830	T-30	1/4"	200	55	200	12.0	0.62	000450
6840	T-40	1/4"	200	55	200	12.0	0.62	000450
6845	T-45	5/16"	200	80	200	17.0	0.62	000600
6850	T-50	5/16"	200	80	200	17.0	0.62	000600
6855	T-55	10mm	200	130	100	14.0	0.44	000800
6860	T-60	12mm	200	190	100	20.0	0.44	001000
6870	T-70	14mm	200	230	100	24.0	0.44	001200

Screwdriver Bits

Tamperproof Star Screwdriver Bits



ITEM NO.	Size	Hex Shank	Length mm	Weight g	PCS 	G.W. KGS	CUFT 	CODE @
7107	T-7	1/4"	30	8	600	6.0	0.30	000085
7108	T-8	1/4"	30	8	600	6.0	0.30	000085
7109	T-9	1/4"	30	8	600	6.0	0.30	000085
7110	T-10	1/4"	30	8	600	6.0	0.30	000085
7115	T-15	1/4"	30	8	600	6.0	0.30	000085
7120	T-20	1/4"	30	8	600	6.0	0.30	000085
7125	T-25	1/4"	30	8	600	6.0	0.30	000085
7127	T-27	1/4"	30	8	600	6.0	0.30	000085
7130	T-30	1/4"	30	8	600	6.0	0.30	000085
7140	T-40	1/4"	30	8	600	6.0	0.30	000085
7145	T-45	5/16"	30	11	600	8.0	0.30	000125
7150	T-50	5/16"	30	11	600	8.0	0.30	000125
7155	T-55	10mm	30	20	300	7.0	0.30	000180
7307	T-7	1/4"	56	15	600	10.0	0.30	000150
7308	T-8	1/4"	56	15	600	10.0	0.30	000150
7309	T-9	1/4"	56	15	600	10.0	0.30	000150
7310	T-10	1/4"	56	15	600	10.0	0.30	000150
7315	T-15	1/4"	56	15	600	10.0	0.30	000150
7320	T-20	1/4"	56	15	600	10.0	0.30	000150
7325	T-25	1/4"	56	15	600	10.0	0.30	000150
7327	T-27	1/4"	56	15	600	10.0	0.30	000150
7330	T-30	1/4"	56	15	600	10.0	0.30	000150
7340	T-40	1/4"	56	15	600	10.0	0.30	000150
7345	T-45	5/16"	56	20	600	13.0	0.30	000190
7350	T-50	5/16"	56	20	600	13.0	0.30	000190
7355	T-55	10mm	56	37	300	12.5	0.52	000250
7360	T-60	12mm	56	54	300	17.5	0.52	000310
7370	T-70	14mm	56	65	300	20.5	0.52	000370
7507	T-7	1/4"	88	24	400	11.0	0.59	000300
7508	T-8	1/4"	88	24	400	11.0	0.59	000300
7509	T-9	1/4"	88	24	400	11.0	0.59	000300
7510	T-10	1/4"	88	24	400	11.0	0.59	000300
7515	T-15	1/4"	88	24	400	11.0	0.59	000300
7520	T-20	1/4"	88	24	400	11.0	0.59	000300
7525	T-25	1/4"	88	24	400	11.0	0.59	000300
7527	T-27	1/4"	88	24	400	11.0	0.59	000300
7530	T-30	1/4"	88	24	400	11.0	0.59	000300
7540	T-40	1/4"	88	24	400	11.0	0.59	000300
7545	T-45	5/16"	88	35	400	15.0	0.59	000340
7550	T-50	5/16"	88	35	400	15.0	0.59	000340
7555	T-55	10mm	88	57	200	12.5	0.44	000440
7560	T-60	12mm	88	85	200	18.0	0.44	000580
7570	T-70	14mm	88	100	200	21.0	0.44	000720
7607	T-7	1/4"	125	34	300	11.5	0.52	000350
7608	T-8	1/4"	125	34	300	11.5	0.52	000350
7609	T-9	1/4"	125	34	300	11.5	0.52	000350
7610	T-10	1/4"	125	34	300	11.5	0.52	000350
7615	T-15	1/4"	125	34	300	11.5	0.52	000350
7620	T-20	1/4"	125	34	300	11.5	0.52	000350
7625	T-25	1/4"	125	34	300	11.5	0.52	000350
7627	T-27	1/4"	125	34	300	11.5	0.52	000350
7630	T-30	1/4"	125	34	300	11.5	0.52	000350
7640	T-40	1/4"	125	34	300	11.5	0.52	000350
7645	T-45	5/16"	125	50	300	16.0	0.52	000450
7650	T-50	5/16"	125	50	300	16.0	0.52	000450
7655	T-55	10mm	125	80	150	13.0	0.52	000650
7660	T-60	12mm	125	120	150	19.0	0.52	000800
7670	T-70	14mm	125	145	150	23.0	0.52	000950



Screwdriver Bits





Tamperproof Star Screwdriver Bits

ITEM NO.	Size	Hex Shank	Length mm	Weight g	PCS 	G.W. KGS	CUFT 	CODE @
7707	T-7	1/4"	160	45	200	9.5	0.62	000430
7708	T-8	1/4"	160	45	200	9.5	0.62	000430
7709	T-9	1/4"	160	45	200	9.5	0.62	000430
7710	T-10	1/4"	160	45	200	9.5	0.62	000430
7715	T-15	1/4"	160	45	200	9.5	0.62	000430
7720	T-20	1/4"	160	45	200	9.5	0.62	000430
7725	T-25	1/4"	160	45	200	9.5	0.62	000430
7727	T-27	1/4"	160	45	200	9.5	0.62	000430
7730	T-30	1/4"	160	45	200	9.5	0.62	000430
7740	T-40	1/4"	160	45	200	9.5	0.62	000430
7745	T-45	5/16"	160	65	200	13.5	0.62	000560
7750	T-50	5/16"	160	65	200	13.5	0.62	000560
7755	T-55	10mm	160	105	100	11.0	0.44	000760
7760	T-60	12mm	160	155	100	16.0	0.44	000930
7770	T-70	14mm	160	190	100	19.5	0.44	001110

7807	T-7	1/4"	200	55	200	12.0	0.62	000510
7808	T-8	1/4"	200	55	200	12.0	0.62	000510
7809	T-9	1/4"	200	55	200	12.0	0.62	000510
7810	T-10	1/4"	200	55	200	12.0	0.62	000510
7815	T-15	1/4"	200	55	200	12.0	0.62	000510
7820	T-20	1/4"	200	55	200	12.0	0.62	000510
7825	T-25	1/4"	200	55	200	12.0	0.62	000510
7827	T-27	1/4"	200	55	200	12.0	0.62	000510
7830	T-30	1/4"	200	55	200	12.0	0.62	000510
7840	T-40	1/4"	200	55	200	12.0	0.62	000510
7845	T-45	5/16"	200	80	200	17.0	0.62	000660
7850	T-50	5/16"	200	80	200	17.0	0.62	000660
7855	T-55	10mm	200	130	100	14.0	0.44	000860
7860	T-60	12mm	200	194	100	20.5	0.44	001060
7870	T-70	14mm	200	234	100	24.5	0.44	001260

7940	T-40	1/4"	225	62	200	14.5	0.62	000590
7945	T-45	5/16"	225	90	200	19.0	0.62	000760

Triple Square Screwdriver Bits

ITEM NO.	Size	Hex Shank	Length mm	Weight g	PCS 	G.W. KGS	CUFT 	CODE @
8104	M4	1/4"	30	8	600	6.0	0.30	000060
8105	M5	1/4"	30	8	600	6.0	0.30	000060
8106	M6	1/4"	30	8	600	6.0	0.30	000060
8108	M8	5/16"	30	11	600	8.0	0.30	000095
8110	M10	10mm	30	20	300	7.0	0.30	000150
8112	M12	12mm	30	29	300	10.0	0.30	000195
8114	M14	14mm	30	35	300	11.5	0.30	000240
8304	M4	1/4"	56	15	600	10.0	0.30	000120
8305	M5	1/4"	56	15	600	10.0	0.30	000120
8306	M6	1/4"	56	15	600	10.0	0.30	000120
8308	M8	5/16"	56	20	600	13.0	0.30	000160
8310	M10	10mm	56	37	300	12.5	0.52	000220
8312	M12	12mm	56	54	300	17.5	0.52	000280
8314	M14	14mm	56	65	300	21.0	0.52	000340
8316	M16	16mm	56	100	150	16.5	0.52	000410
8504	M4	1/4"	88	24	400	11.0	0.59	000260
8505	M5	1/4"	88	24	400	11.0	0.59	000260
8506	M6	1/4"	88	24	400	11.0	0.59	000260
8508	M8	5/16"	88	35	400	15.0	0.59	000300
8510	M10	10mm	88	57	200	12.5	0.44	000400
8512	M12	12mm	88	85	200	18.0	0.44	000540
8514	M14	14mm	88	100	200	21.0	0.44	000680
8516	M16	16mm	88	160	100	17.0	0.44	000770
8604	M4	1/4"	125	34	300	11.5	0.52	000300
8605	M5	1/4"	125	34	300	11.5	0.52	000300
8606	M6	1/4"	125	34	300	11.5	0.52	000300
8608	M8	5/16"	125	50	300	16.0	0.52	000400
8610	M10	10mm	125	80	150	13.0	0.52	000600
8612	M12	12mm	125	120	150	19.0	0.52	000750
8614	M14	14mm	125	145	150	23.0	0.52	000900
8616	M16	16mm	125	230	80	20.0	0.44	001050
8704	M4	1/4"	160	45	200	9.5	0.62	000380
8705	M5	1/4"	160	45	200	9.5	0.62	000380
8706	M6	1/4"	160	45	200	9.5	0.62	000380
8708	M8	5/16"	160	65	200	13.5	0.62	000500
8710	M10	10mm	160	105	100	11.0	0.44	000700
8712	M12	12mm	160	155	100	16.0	0.44	000880
8714	M14	14mm	160	190	100	19.5	0.44	001050
8716	M16	16mm	160	300	60	18.5	0.44	001230
8804	M4	1/4"	200	55	200	12.0	0.62	000450
8805	M5	1/4"	200	55	200	12.0	0.62	000450
8806	M6	1/4"	200	55	200	12.0	0.62	000450
8808	M8	5/16"	200	80	200	17.0	0.62	000600
8810	M10	10mm	200	130	100	14.0	0.44	000800
8812	M12	12mm	200	194	100	21.0	0.44	001000
8814	M14	14mm	200	234	100	25.0	0.44	001200
8816	M16	16mm	200	365	60	23.0	0.44	001400



Screwdriver Bits



Square Screwdriver Bits



ITEM NO.	Size	Hex Shank	Length mm	Weight g	PCS	G.W. KGS	CUFT	CODE @
9100	S# 0	1/4"	30	8	600	6.0	0.30	000060
9101	S# 1	1/4"	30	8	600	6.0	0.30	000060
9102	S# 2	1/4"	30	8	600	6.0	0.30	000060
9103	S# 3	1/4"	30	8	600	6.0	0.30	000060
9104	S# 4	1/4"	30	8	600	6.0	0.30	000060
9300	S# 0	1/4"	56	15	600	10.0	0.30	000120
9301	S# 1	1/4"	56	15	600	10.0	0.30	000120
9302	S# 2	1/4"	56	15	600	10.0	0.30	000120
9303	S# 3	1/4"	56	15	600	10.0	0.30	000120
9304	S# 4	1/4"	56	15	600	10.0	0.30	000120
9500	S# 0	1/4"	88	24	400	11.0	0.59	000260
9501	S# 1	1/4"	88	24	400	11.0	0.59	000260
9502	S# 2	1/4"	88	24	400	11.0	0.59	000260
9503	S# 3	1/4"	88	24	400	11.0	0.59	000260
9504	S# 4	1/4"	88	24	400	11.0	0.59	000260
9600	S# 0	1/4"	125	34	300	11.5	0.52	000300
9601	S# 1	1/4"	125	34	300	11.5	0.52	000300
9602	S# 2	1/4"	125	34	300	11.5	0.52	000300
9603	S# 3	1/4"	125	34	300	11.5	0.52	000300
9604	S# 4	1/4"	125	34	300	11.5	0.52	000300
9700	S# 0	1/4"	160	45	200	9.5	0.62	000380
9701	S# 1	1/4"	160	45	200	9.5	0.62	000380
9702	S# 2	1/4"	160	45	200	9.5	0.62	000380
9703	S# 3	1/4"	160	45	200	9.5	0.62	000380
9704	S# 4	1/4"	160	45	200	9.5	0.62	000380
9800	S# 0	1/4"	200	55	200	12.0	0.62	000450
9801	S# 1	1/4"	200	55	200	12.0	0.62	000450
9802	S# 2	1/4"	200	55	200	12.0	0.62	000450
9803	S# 3	1/4"	200	55	200	12.0	0.62	000450
9804	S# 4	1/4"	200	55	200	12.0	0.62	000450



Power Screwdriver Bits

Slotted Screwdriver Bits

ITEM NO.	Size mm	Hex Shank	Length mm	Weight g	PCS 	G.W. KGS	CUFT 	CODE @
205030	0.5X3.0	1/4"	50	12	600	8.5	0.30	000070
205040	0.6X4.0	1/4"	50	12	600	8.5	0.30	000070
205050	0.8X5.0	1/4"	50	12	600	8.5	0.30	000070
205055	0.8X5.5	1/4"	50	12	600	8.5	0.30	000070
205060	1.0X6.0	1/4"	50	12	600	8.5	0.30	000070
205065	1.0X6.5	1/4"	50	12	600	8.5	0.30	000070
205070	1.2X7.0	1/4"	50	12	600	8.5	0.30	000070
217250	0.8X5.0	5/16"	72	30	300	10.0	0.30	000172
217255	0.8X5.5	5/16"	72	30	300	10.0	0.30	000172
217260	1.0X6.0	5/16"	72	30	300	10.0	0.30	000172
217265	1.0X6.5	5/16"	72	30	300	10.0	0.30	000172
217270	1.2X8.0	5/16"	72	30	300	10.0	0.30	000172
217280	1.6X9.0	5/16"	72	30	300	10.0	0.30	000172





Philips Screwdriver Bits

ITEM NO.	Size	Hex Shank	Length mm	Weight g	PCS 	G.W. KGS	CUFT 	CODE @
235000	#0	1/4"	50	12	600	8.2	0.30	000070
235001	#1	1/4"	50	12	600	8.2	0.30	000070
235002	#2	1/4"	50	12	600	8.2	0.30	000070
235003	#3	1/4"	50	12	600	8.2	0.30	000070
247201	#1	5/16"	72	30	300	10.0	0.30	000172
247202	#2	5/16"	72	30	300	10.0	0.30	000172
247203	#3	5/16"	72	30	300	10.0	0.30	000172
247204	#4	5/16"	72	30	300	10.0	0.30	000172



POSIDRIV Screwdriver Bits



ITEM NO.	Size	Hex Shank	Length mm	Weight g	PCS 	G.W. KGS	CUFT 	CODE @
255001	#1	1/4"	50	12	600	8.5	0.30	000070
255002	#2	1/4"	50	12	600	8.5	0.30	000070
255003	#3	1/4"	50	12	600	8.5	0.30	000070
277201	#1	5/16"	72	30	300	10.0	0.30	000172
277202	#2	5/16"	72	30	300	10.0	0.30	000172
272203	#3	5/16"	72	30	300	10.0	0.30	000172
277204	#4	5/16"	72	30	300	10.0	0.30	000172



Power Screwdriver Bits





Metric Hex Screwdriver Bits

ITEM NO.	Size mm	Hex Shank	Length mm	Weight g	PCS 	G.W. KGS	CUFT 	CODE @
265020	2	1/4"	50	12	600	8.5	0.30	000070
265025	2.5	1/4"	50	12	600	8.5	0.30	000070
265030	3	1/4"	50	12	600	8.5	0.30	000070
265040	4	1/4"	50	12	600	8.5	0.30	000070
265050	5	1/4"	50	12	600	8.5	0.30	000070
265060	6	1/4"	50	12	600	8.5	0.30	000070
297230	3	5/16"	72	30	300	10.0	0.30	000172
297240	4	5/16"	72	30	300	10.0	0.30	000172
297250	5	5/16"	72	30	300	10.0	0.30	000172
297260	6	5/16"	72	30	300	10.0	0.30	000172
297270	7	5/16"	72	30	300	10.0	0.30	000172
297280	8	5/16"	72	30	300	10.0	0.30	000172





SAE Hex Screwdriver Bits



ITEM NO.	Size Inch	Hex Shank	Length mm	Weight g	PCS 	G.W. KGS	CUFT 	CODE @
275003	3/32	1/4"	50	12	600	8.5	0.30	000070
275004	1/8	1/4"	50	12	600	8.5	0.30	000070
275005	5/32	1/4"	50	12	600	8.5	0.30	000070
275006	3/16	1/4"	50	12	600	8.5	0.30	000070
275007	7/32	1/4"	50	12	600	8.5	0.30	000070
275008	1/4	1/4"	50	12	600	8.5	0.30	000070
297204	1/8	5/16"	72	30	300	10.0	0.30	000172
297205	5/32	5/16"	72	30	300	10.0	0.30	000172
297206	3/16	5/16"	72	30	300	10.0	0.30	000172
297207	7/32	5/16"	72	30	300	10.0	0.30	000172
297208	1/4	5/16"	72	30	300	10.0	0.30	000172
297209	9/32	5/16"	72	30	300	10.0	0.30	000172
297210	5/16	5/16"	72	30	300	10.0	0.30	000172



Star Screwdriver Bits

ITEM NO.	Size	Hex Shank	Length mm	Weight g	PCS 	G.W. KGS	CUFT 	CODE @
285008	T-8	1/4"	50	12	600	8.5	0.30	000070
285010	T-10	1/4"	50	12	600	8.5	0.30	000070
285015	T-15	1/4"	50	12	600	8.5	0.30	000070
285020	T-20	1/4"	50	12	600	8.5	0.30	000070
285025	T-25	1/4"	50	12	600	8.5	0.30	000070
285027	T-27	1/4"	50	12	600	8.5	0.30	000070
285030	T-30	1/4"	50	12	600	8.5	0.30	000070
285040	T-40	1/4"	50	12	600	8.5	0.30	000070
227210	T-10	5/16"	72	30	300	10.0	0.30	000172
227215	T-15	5/16"	72	30	300	10.0	0.30	000172
227220	T-20	5/16"	72	30	300	10.0	0.30	000172
227225	T-25	5/16"	72	30	300	10.0	0.30	000172
227227	T-27	5/16"	72	30	300	10.0	0.30	000172
227230	T-30	5/16"	72	30	300	10.0	0.30	000172
227240	T-40	5/16"	72	30	300	10.0	0.30	000172
227245	T-45	5/16"	72	30	300	10.0	0.30	000172
227250	T-50	5/16"	72	30	300	10.0	0.30	000172

Bit Holders

ITEM NO.	Drive	Hex Shank	Length mm	Weight g	PCS 	G.W. KGS	CUFT 	CODE @
208+	1/4"	1/4"	25	10	300	4.0	0.69	000200
308+	3/8"	1/4"	28	30	300	10.0	0.69	000260
310+	3/8"	5/16"	30	35	300	11.5	0.69	000260
312+	3/8"	3/8"	30	45	300	14.5	0.69	000300
314+	3/8"	7/16"	30	45	300	14.5	0.69	000300
316+	3/8"	1/2"	30	45	300	14.5	0.69	000300
339+	3/8"	9mm	30	40	300	13.0	0.69	000300
340+	3/8"	10mm	30	45	300	14.5	0.69	000300
341+	3/8"	11mm	30	45	300	14.5	0.69	000300
342+	3/8"	12mm	30	45	300	14.5	0.69	000300
344+	3/8"	14mm	30	50	300	16.0	0.69	000340
408+	1/2"	1/4"	36	60	200	13.0	0.59	000380
410+	1/2"	5/16"	38	65	200	14.0	0.59	000380
412+	1/2"	3/8"	40	70	200	15.0	0.59	000400
414+	1/2"	7/16"	40	75	200	16.0	0.59	000400
416+	1/2"	1/2"	40	80	200	17.0	0.59	000400
418+	1/2"	9/16"	40	80	200	17.0	0.59	000400
420+	1/2"	5/8"	40	90	200	19.0	0.59	000430
422+	1/2"	11/16"	40	98	200	21.0	0.59	000450
424+	1/2"	3/4"	40	130	200	27.0	0.59	000500
439+	1/2"	9mm	40	70	200	15.0	0.59	000400
440+	1/2"	10mm	40	70	200	15.0	0.59	000400
441+	1/2"	11mm	40	75	200	16.0	0.59	000400
442+	1/2"	12mm	40	75	200	16.0	0.59	000400
443+	1/2"	13mm	40	80	200	17.0	0.59	000400
444+	1/2"	14mm	40	80	200	17.0	0.59	000400
446+	1/2"	16mm	40	90	200	19.0	0.59	000430
447+	1/2"	17mm	40	98	200	21.0	0.59	000450
449+	1/2"	19mm	40	130	200	27.0	0.59	000500



Bit Holders(quick change)

ITEM NO.	Drive	Hex Shank	Length mm	Weight g	PCS 	G.W. KGS	CUFT 	CODE @
283508	1/4"	1/4"	35	30	200	7.0	0.52	000475
283510	1/4"	5/16"	35	35	200	8.0	0.52	000495
384608	3/8"	1/4"	46	40	200	9.0	0.52	000475
383908	3/8"	1/4"	39	35	200	8.0	0.52	000475
384610	3/8"	5/16"	46	60	200	13.0	0.52	000495
383910	3/8"	5/16"	39	50	200	11.0	0.52	000495
383912	3/8"	3/8"	39	50	200	11.0	0.52	000520
323910	3/8"	10mm	39	50	200	11.0	0.52	000520
484808	1/2"	1/4"	48	60	200	13.0	0.52	000525
484108	1/2"	1/4"	41	55	200	12.0	0.52	000525
484810	1/2"	5/16"	48	80	200	17.0	0.52	000565
484110	1/2"	5/16"	41	62	200	13.5	0.52	000565
484112	1/2"	3/8"	41	62	200	13.5	0.52	000620
484314	1/2"	7/16"	43	80	200	17.0	0.52	000660
484516	1/2"	1/2"	45	100	200	21.0	0.52	000700
424110	1/2"	10mm	41	62	200	13.5	0.52	000620
424312	1/2"	12mm	43	80	200	17.0	0.52	000660
424514	1/2"	14mm	45	100	200	21.0	0.52	000700



Accessories



OMNIDRIVE® 3in1 Handgrip

ITEM NO.	Hex Shank	Hex Shank	Hex Shank	Length mm	Weight g	PCS	G.W. KGS	CUFT	CODE @
280120	1/4"	1/4"	5/16"	120	125	80	11.0	1.60	000990

The 3in1 handgrip, OMNIDRIVE®, provides the functions of screwdrivers for rapid screwing, hex shank drivers with interchangeable sizes of 1/4" and 5/16", and T-handles for a stronger tightening action.

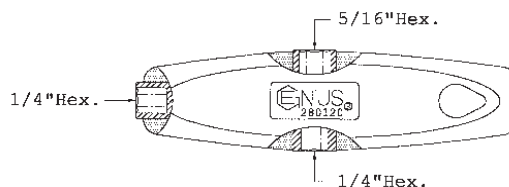

Flexible Extension

ITEM NO.	Male Drive	Female Drive	Length mm	Weight g	PCS	G.W. KGS	CUFT	CODE @
282150	1/4"	1/4"	150	60	240	15.5	0.3	000440

Flexible Bit Holder

ITEM NO.	Hex Shank	Female Drive	Length mm	Weight g	PCS	G.W. KGS	CUFT	CODE @
282165	1/4"	1/4"	165	70	240	18.0	0.30	000380

Flexible Bit Holder

ITEM NO.	Hex Shank	Hex Drive	Length mm	Weight g	PCS	G.W. KGS	CUFT	CODE @
0260	1/4"	1/4"	180	75	240	19.0	0.30	000480

Flexible Extension

ITEM NO.	Square Drive	Hex Drive	Length mm	Weight g	PCS	G.W. KGS	CUFT	CODE @
0250	1/4"	1/4"	170	65	240	17.0	0.30	000570



Magnetic Bit Holder

ITEM NO.	Hex Shank	Hex Drive	Length mm	Weight g	PCS	G.W. KGS	CUFT	CODE @
0230	1/4"	1/4"	150	50	240	13.0	0.30	000570



Spinner Handles

ITEM NO.	Square Drive	Hex Drive	Length mm	Weight g	PCS	G.W. KGS	CUFT	CODE @
272065	1/4"	1/4"	65	20	240	6.0	0.30	000200
273065	3/8"	1/4"	65	25	240	8.0	0.30	000250
272140	1/4"	1/4"	140	50	240	13.0	0.30	000400



Magnetic Bit Holder With Handle

ITEM NO.	Hex Shank	L1 mm	Length mm	Weight g	PCS 	G.W. KGS	CUFT 	CODE @
594 + 0230	1/4"	125	230	115	100	12.5	1.26	000800



Flexible Bit Holder With Handle

ITEM NO.	Hex Shank	L1 mm	Length mm	Weight g	PCS 	G.W. KGS	CUFT 	CODE @
594 + 0260	1/4"	125	260	125	100	13.5	1.26	000710



Flexible Spinner With Handle

ITEM NO.	Square Drive	L1 mm	Length mm	Weight g	PCS 	G.W. KGS	CUFT 	CODE @
594 + 0250	1/4"	125	250	115	100	12.5	1.26	000800



Bit Holder With Handle

ITEM NO.	Hex Shank	Length mm	Weight g	PCS 	G.W. KGS	CUFT 	CODE @
280150	1/4"	150	110	100	12.0	1.26	000700

Bit Holder With Ratchet Handle



ITEM NO.	Hex Shank	Length mm	Weight g	PCS 	G.W. KGS	CUFT 	CODE @
280170	1/4"	230	220	80	18	1.50	001600

Magnetic Bit Holder Adapters

ITEM NO.	Hex Shank	Hex Drive	Length mm	Weight g	PCS 	G.W. KGS	CUFT 	CODE @
286008	1/4"	1/4"	60	30	240	8.5	0.30	000320
286008M	1/4"	1/4"	60	30	240	8.5	0.30	000320



- 286008 is direct fitting for electric and pneumatic impact wrenches

Magnetic Bit Holder Adapters



ITEM NO.	Hex Shank	Hex Drive	Length mm	Weight g	PCS 	G.W. KGS	CUFT 	CODE @
285708	1/4"	1/4"	60	45	240	12.0	0.30	000580
285708M	1/4"	1/4"	60	45	240	12.0	0.30	000580

- Model with quick release sleeve
- 285708 is direct fitting for electric and pneumatic impact wrenches



Bit Holder Adapters

ITEM NO.	Hex Shank	Hex Drive	Length mm	Weight g	PCS 	G.W. KGS	CUFT 	CODE @
285608	1/4"	1/4"	60	30	240	8.5	0.30	000220

Magnetic Bit Holder With Handle

ITEM NO.	L1 mm	Length mm	Weight g	PCS 	G.W. KGS	CUFT 	CODE @
280060	12	60	40	200	9.0	1.39	000540

Socket Holder Adapter

ITEM NO.	Square Drive	Hex Drive	Length mm	Weight g	PCS 	G.W. KGS	CUFT 	CODE @
280002B	1/4"	1/4"	30	8	600	6.0	0.30	000100



Screwdriver Bit Sets

TX-246M 46 Piece Metric Extra Long Complete Screwdriver Bits With OMNIDRIVE® Set

Item No.	Description	Item No.	Description
280120	OMNIDRIVE® 3in1 Handgrip	6725	T-25 Star Screwdriver Bit
Slotted Screwdriver Bit 160mmL:			
1740	0.6 x 4.0 Slotted Screwdriver Bit	6730	T-30 Star Screwdriver Bit
1750	0.8 x 5.0 Slotted Screwdriver Bit	6740	T-40 Star Screwdriver Bit
1760	1.0 x 6.0 Slotted Screwdriver Bit	6745	T-45 Star Screwdriver Bit
1780	1.2 x 8.0 Slotted Screwdriver Bit	6750	T-50 Star Screwdriver Bit
Philips Screwdriver Bit 160mmL:			
1701	#1 Philips Screwdriver Bit	Triple Square Screwdriver Bit 160mmL:	
1702	#2 Philips Screwdriver Bit	8704	M4 Triple Square Screwdriver Bit
1703	#3 Philips Screwdriver Bit	8705	M5 Triple Square Screwdriver Bit
1704	#4 Philips Screwdriver Bit	8706	M6 Triple Square Screwdriver Bit
Metric Hex Screwdriver Bit 160mmL:			
2725	2.5mm Hex Screwdriver Bit	8708	M8 Triple Square Screwdriver Bit
2733	3mm Hex Screwdriver Bit	1/4" Dr. Six-Point Hand Socket:	
2734	4mm Hex Screwdriver Bit	222504	4mm Hand Socket
2735	5mm Hex Screwdriver Bit	222505	5mm Hand Socket
2736	6mm Hex Screwdriver Bit	222506	6mm Hand Socket
2747	7mm Hex Screwdriver Bit	222507	7mm Hand Socket
2748	8mm Hex Screwdriver Bit	222508	8mm Hand Socket
Star Screwdriver Bit 160mmL:			
6706	T-6 Star Screwdriver Bit	222509	9mm Hand Socket
6707	T-7 Star Screwdriver Bit	222510	10mm Hand Socket
6708	T-8 Star Screwdriver Bit	222511	11mm Hand Socket
6709	T-9 Star Screwdriver Bit	222512	12mm Hand Socket
6710	T-10 Star Screwdriver Bit	222513	13mm Hand Socket
6715	T-15 Star Screwdriver Bit	Accessory:	
6720	T-20 Star Screwdriver Bit	272065	1/4" Dr. Spinner Handle 65mmL
		272140	1/4" Dr. Spinner Handle 140mmL
		280070	1/4" Dr. Universal Joint 40mmL
			Blow Case

2460 g 4 Sets / 11 Kgs / 1.07 CUFT CODE : 014700

TX-246M
(TX-246S)



TX-246S 46 Piece SAE Extra Long Complete Screwdriver Bits With OMNIDRIVE® Set

Item No.	Description
280120	OMNIDRIVE® 3in1 Handgrip
Slotted Screwdriver Bit 160mmL:	
1740	0.6 x 4.0 Slotted Screwdriver Bit
1750	0.8 x 5.0 Slotted Screwdriver Bit
1760	1.0 x 6.0 Slotted Screwdriver Bit
1780	1.2 x 8.0 Slotted Screwdriver Bit
Philips Screwdriver Bit 160mmL:	
1701	#1 Philips Screwdriver Bit
1702	#2 Philips Screwdriver Bit
1703	#3 Philips Screwdriver Bit
1704	#4 Philips Screwdriver Bit
SAE Hex Screwdriver Bit 160mmL:	
3708	1/8" Hex Screwdriver Bit
3710	5/32" Hex Screwdriver Bit
3712	3/16" Hex Screwdriver Bit
3714	7/32" Hex Screwdriver Bit
3716	1/4" Hex Screwdriver Bit
3718	9/32" Hex Screwdriver Bit
3720	5/16" Hex Screwdriver Bit
Star Screwdriver Bit 160mmL:	
6706	T-6 Star Screwdriver Bit
6707	T-7 Star Screwdriver Bit
6708	T-8 Star Screwdriver Bit
6709	T-9 Star Screwdriver Bit
6710	T-10 Star Screwdriver Bit
6715	T-15 Star Screwdriver Bit
6720	T-20 Star Screwdriver Bit
6725	T-25 Star Screwdriver Bit
6727	T-27 Star Screwdriver Bit
6730	T-30 Star Screwdriver Bit
6740	T-40 Star Screwdriver Bit
6745	T-45 Star Screwdriver Bit
6750	T-50 Star Screwdriver Bit
Triple Square Screwdriver Bit 160mmL:	
8704	M4 Triple Square Screwdriver Bit
8705	M5 Triple Square Screwdriver Bit
8706	M6 Triple Square Screwdriver Bit
8708	M8 Triple Square Screwdriver Bit
1/4" Dr. Six-Point Hand Socket:	
282504	1/8" Hand Socket
282506	3/16" Hand Socket
282507	7/32" Hand Socket
282508	1/4" Hand Socket
282509	9/32" Hand Socket
282510	5/16" Hand Socket
282511	11/32" Hand Socket
282512	3/8" Hand Socket
282514	7/16" Hand Socket
282516	1/2" Hand Socket
Accessory:	
272065	1/4" Dr. Spinner Handle 65mmL
272140	1/4" Dr. Spinner Handle 140mmL
280070	1/4" Dr. Universal Joint 40mmL
	Blow Case

2460 g CODE : 014700
4 Sets / 11 Kgs / 1.07 CUFT

Screwdriver Bit Sets

TX-23475M 75 Piece Metric Complete Screwdriver Bit Set

Item No.	Description	Item No.	Description
Metric Hex Screwdriver Bit 30mmL:			
2122	2mm Hex Screwdriver Bit	6250	T-50 Star Screwdriver Bit
2125	2.5mm Hex Screwdriver Bit	6255	T-55 Star Screwdriver Bit
Tamperproof Star Screwdriver Bit 88mmL:			
2133	3mm Hex Screwdriver Bit	7507	T-7 Tamperproof Star Screwdriver Bit
2134	4mm Hex Screwdriver Bit	7508	T-8 Tamperproof Star Screwdriver Bit
2135	5mm Hex Screwdriver Bit	7509	T-9 Tamperproof Star Screwdriver Bit
2136	6mm Hex Screwdriver Bit	7510	T-10 Tamperproof Star Screwdriver Bit
2147	7mm Hex Screwdriver Bit	7515	T-15 Tamperproof Star Screwdriver Bit
2148	8mm Hex Screwdriver Bit	7520	T-20 Tamperproof Star Screwdriver Bit
2149	9mm Hex Screwdriver Bit	7525	T-25 Tamperproof Star Screwdriver Bit
2150	10mm Hex Screwdriver Bit	7527	T-27 Tamperproof Star Screwdriver Bit
2151	11mm Hex Screwdriver Bit	7530	T-30 Tamperproof Star Screwdriver Bit
2152	12mm Hex Screwdriver Bit	7540	T-40 Tamperproof Star Screwdriver Bit
Metric Hex Screwdriver Bit 88mmL:			
2522	2mm Hex Screwdriver Bit	7545	T-45 Tamperproof Star Screwdriver Bit
2525	2.5mm Hex Screwdriver Bit	7550	T-50 Tamperproof Star Screwdriver Bit
2533	3mm Hex Screwdriver Bit	7555	T-55 Tamperproof Star Screwdriver Bit
2534	4mm Hex Screwdriver Bit	7560	T-60 Tamperproof Star Screwdriver Bit
2535	5mm Hex Screwdriver Bit	7570	T-70 Tamperproof Star Screwdriver Bit
2536	6mm Hex Screwdriver Bit	Triple Square Screwdriver Bit 30mmL:	
2547	7mm Hex Screwdriver Bit	8104	M4 Triple Square Screwdriver Bit
2548	8mm Hex Screwdriver Bit	8105	M5 Triple Square Screwdriver Bit
2549	9mm Hex Screwdriver Bit	8106	M6 Triple Square Screwdriver Bit
2550	10mm Hex Screwdriver Bit	8108	M8 Triple Square Screwdriver Bit
2551	11mm Hex Screwdriver Bit	8110	M10 Triple Square Screwdriver Bit
2552	12mm Hex Screwdriver Bit	8112	M12 Triple Square Screwdriver Bit
2553	13mm Hex Screwdriver Bit	8114	M14 Triple Square Screwdriver Bit
2554	14mm Hex Screwdriver Bit	Triple Square Screwdriver Bit 88mmL:	
Star Screwdriver Bit 30mmL:			
6106	T-6 Star Screwdriver Bit	8504	M4 Triple Square Screwdriver Bit
6107	T-7 Star Screwdriver Bit	8505	M5 Triple Square Screwdriver Bit
6108	T-8 Star Screwdriver Bit	8506	M6 Triple Square Screwdriver Bit
6109	T-9 Star Screwdriver Bit	8508	M8 Triple Square Screwdriver Bit
6110	T-10 Star Screwdriver Bit	8510	M10 Triple Square Screwdriver Bit
6115	T-15 Star Screwdriver Bit	8512	M12 Triple Square Screwdriver Bit
6120	T-20 Star Screwdriver Bit	8514	M14 Triple Square Screwdriver Bit
6125	T-25 Star Screwdriver Bit	Bit Holders:	
6127	T-27 Star Screwdriver Bit	283508	1/4" Dr. 1/4" Hex Shank Bit Holder
6130	T-30 Star Screwdriver Bit	383910	3/8" Dr. 5/16" Hex Shank Bit Holder
6140	T-40 Star Screwdriver Bit	484110	1/2" Dr. 5/16" Hex Shank Bit Holder
6245	T-45 Star Screwdriver Bit	424110	1/2" Dr. 10mm Hex S hank Bit Holder
		424312	1/2" Dr. 12mm Hex Shank Bit Holder
		424514	1/2" Dr. 14mm Hex Shank Bit Holder
			Blow Case

3200 g 4 Sets / 14 Kgs / 1.07 CUFT CODE : 018700

TX-23475M



SB-221SP 21 Piece Slotted & Philips Screwdriver Bit Set

Item No.	Description
280120	OMNIDRIVE® 3in1 Handgrip
Slotted Screwdriver Bit 30mmL:	
1130	0.5 x 3.0 Slotted Screwdriver Bit
1140	0.6 x 4.0 Slotted Screwdriver Bit
1150	0.8 x 5.0 Slotted Screwdriver Bit
1155	0.8 x 5.5 Slotted Screwdriver Bit
1160	1.0 x 6.0 Slotted Screwdriver Bit
1170	1.2 x 7.0 Slotted Screwdriver Bit
Slotted Screwdriver Bit 160mmL:	
1740	0.6 x 4.0 Slotted Screwdriver Bit
1750	0.8 x 5.0 Slotted Screwdriver Bit
1760	1.0 x 6.0 Slotted Screwdriver Bit
1780	1.2 x 8.0 Slotted Screwdriver Bit
1790	1.6 x 9.0 Slotted Screwdriver Bit
Philips Screwdriver Bit 30mmL:	
1100	#0 Philips Screwdriver Bit
1101	#1 Philips Screwdriver Bit
1102	#2 Philips Screwdriver Bit
1103	#3 Philips Screwdriver Bit
Philips Screwdriver Bit 160mmL:	
1701	#1 Philips Screwdriver Bit
1702	#2 Philips Screwdriver Bit
1703	#3 Philips Screwdriver Bit
1704	#4 Philips Screwdriver Bit

Accessory:
280002B Socket Holder Adapter
Kit Bag

880 g CODE : 005150
20 Sets / 18.5 Kgs / 0.73 CUFT

SB-221SP



Screwdriver Bit Sets

TX-23478S 78 Piece SAE Complete Screwdriver Bit Set

Item No.	Description	Item No.	Description	Item No.	Description	
SAE Hex Screwdriver Bit 30mmL:			6106	T-6 Star Screwdriver Bit	7570	T-70 Tamperproof Star Screwdriver Bit
3106	3/32" Hex Screwdriver Bit	6107	T-7 Star Screwdriver Bit	Triple Square Screwdriver Bit 30mmL:		
3107	7/64" Hex Screwdriver Bit	6108	T-8 Star Screwdriver Bit	8104	M4 Triple Square Screwdriver Bit	
3108	1/8" Hex Screwdriver Bit	6109	T-9 Star Screwdriver Bit	8105	M5 Triple Square Screwdriver Bit	
3110	5/32" Hex Screwdriver Bit	6110	T-10 Star Screwdriver Bit	8106	M6 Triple Square Screwdriver Bit	
3112	3/16" Hex Screwdriver Bit	6115	T-15 Star Screwdriver Bit	8108	M8 Triple Square Screwdriver Bit	
3114	7/32" Hex Screwdriver Bit	6120	T-20 Star Screwdriver Bit	8110	M10 Triple Square Screwdriver Bit	
3116	1/4" Hex Screwdriver Bit	6125	T-25 Star Screwdriver Bit	8112	M12 Triple Square Screwdriver Bit	
3128	9/32" Hex Screwdriver Bit	6127	T-27 Star Screwdriver Bit	8114	M14 Triple Square Screwdriver Bit	
3130	5/16" Hex Screwdriver Bit	6130	T-30 Star Screwdriver Bit	Triple Square Screwdriver Bit 88mmL:		
3134	3/8" Hex Screwdriver Bit	6140	T-40 Star Screwdriver Bit	8504	M4 Triple Square Screwdriver Bit	
3138	7/16" Hex Screwdriver Bit	6245	T-45 Star Screwdriver Bit	8505	M5 Triple Square Screwdriver Bit	
3142	1/2" Hex Screwdriver Bit	6250	T-50 Star Screwdriver Bit	8506	M6 Triple Square Screwdriver Bit	
SAE Hex Screwdriver Bit 88mmL:			6255	T-55 Star Screwdriver Bit	8508	M8 Triple Square Screwdriver Bit
3504	1/16" Hex Screwdriver Bit	Tamperproof Star Screwdriver Bit 88mmL:			8510	M10 Triple Square Screwdriver Bit
3505	5/64" Hex Screwdriver Bit	7507	T-7 Tamperproof Star Screwdriver Bit	8512	M12 Triple Square Screwdriver Bit	
3506	3/32" Hex Screwdriver Bit	7508	T-8 Tamperproof Star Screwdriver Bit	8514	M14 Triple Square Screwdriver Bit	
3507	7/64" Hex Screwdriver Bit	7509	T-9 Tamperproof Star Screwdriver Bit	Bit Holders:		
3508	1/8" Hex Screwdriver Bit	7510	T-10 Tamperproof Star Screwdriver Bit	283508	1/4" Dr. 1/4" Hex Shank Bit Holder	
3510	5/32" Hex Screwdriver Bit	7515	T-15 Tamperproof Star Screwdriver Bit	383910	3/8" Dr. 5/16" Hex Shank Bit Holder	
3512	3/16" Hex Screwdriver Bit	7520	T-20 Tamperproof Star Screwdriver Bit	484110	1/2" Dr. 5/16" Hex Shank Bit Holder	
3514	7/32" Hex Screwdriver Bit	7525	T-25 Tamperproof Star Screwdriver Bit	484112	1/2" Dr. 3/8" Hex Shank Bit Holder	
3516	1/4" Hex Screwdriver Bit	7527	T-27 Tamperproof Star Screwdriver Bit	484314	1/2" Dr. 7/16" Hex Shank Bit Holder	
3518	9/32" Hex Screwdriver Bit	7530	T-30 Tamperproof Star Screwdriver Bit	484516	1/2" Dr. 1/2" Hex Shank Bit Holder	
3520	5/16" Hex Screwdriver Bit	7540	T-40 Tamperproof Star Screwdriver Bit	424110	1/2" Dr. 10mm Hex Shank Bit Holder	
3524	3/8" Hex Screwdriver Bit	7545	T-45 Tamperproof Star Screwdriver Bit	424312	1/2" Dr. 12mm Hex Shank Bit Holder	
3528	7/16" Hex Screwdriver Bit	7550	T-50 Tamperproof Star Screwdriver Bit	424514	1/2" Dr. 14mm Hex Shank Bit Holder	
3532	1/2" Hex Screwdriver Bit	7555	T-55 Tamperproof Star Screwdriver Bit	Blow Case		
Star Screwdriver Bit 30mmL:			7560	T-60 Tamperproof Star Screwdriver Bit		

3400 g

4 Sets / 15 Kgs / 1.07 CUFT

CODE : 019700

TX-23478S



SB-220MH

SB-220MH 20 Piece Metric Hex Screwdriver Bit Set

Item No.	Description
280120	OMNIDRIVE® 3in1 Handgrip
Slotted Screwdriver Bit 30mmL:	
1150	0.8 x 5.0 Slotted Screwdriver Bit
1165	1.0 x 6.5 Slotted Screwdriver Bit
Philips Screwdriver Bit 30mmL:	
1101	#1 Philips Screwdriver Bit
1102	#2 Philips Screwdriver Bit
1103	#3 Philips Screwdriver Bit
Metric Hex Screwdriver Bit 30mmL:	
2122	2mm Hex Screwdriver Bit
2125	2.5mm Hex Screwdriver Bit
2133	3mm Hex Screwdriver Bit
2134	4mm Hex Screwdriver Bit
2135	5mm Hex Screwdriver Bit
2136	6mm Hex Screwdriver Bit
Metric Hex Screwdriver Bit 160mmL:	
2722	2mm Hex Screwdriver Bit
2725	2.5mm Hex Screwdriver Bit
2733	3mm Hex Screwdriver Bit
2734	4mm Hex Screwdriver Bit
2735	5mm Hex Screwdriver Bit
2736	6mm Hex Screwdriver Bit
2747	7mm Hex Screwdriver Bit
2748	8mm Hex Screwdriver Bit

Kit Bag

810 g



CODE : 004630

20 Sets / 17.5 Kgs / 0.73 CUFT

Screwdriver Bit Sets

SB-223SH 23 Piece SAE Hex Screwdriver Bit Set

Item No.	Description
280120	OMNIDRIVE® 3in1 Handgrip
SAE Hex Screwdriver Bit 30mmL:	
3104	1/16" Hex Screwdriver Bit
3105	5/64" Hex Screwdriver Bit
3106	3/32" Hex Screwdriver Bit
3107	7/64" Hex Screwdriver Bit
3108	1/8" Hex Screwdriver Bit
3110	5/32" Hex Screwdriver Bit
3112	3/16" Hex Screwdriver Bit
3114	7/32" Hex Screwdriver Bit
3116	1/4" Hex Screwdriver Bit
273009	9/32" Hex Screwdriver Bit
273010	5/16" Hex Screwdriver Bit
SAE Hex Screwdriver Bit 160mmL:	
3704	1/16" Hex Screwdriver Bit
3705	5/64" Hex Screwdriver Bit
3706	3/32" Hex Screwdriver Bit
3707	7/64" Hex Screwdriver Bit
3708	1/8" Hex Screwdriver Bit
3710	5/32" Hex Screwdriver Bit
3712	3/16" Hex Screwdriver Bit
3714	7/32" Hex Screwdriver Bit
3716	1/4" Hex Screwdriver Bit
3718	9/32" Hex Screwdriver Bit
3720	5/16" Hex Screwdriver Bit

 950 g CODE : 005730
 20 Sets / 20 Kgs / 0.73 CUFT



SB-218MWH 18 Piece Metric Wobble Hex Screwdriver Bit Set

Item No.	Description
280120	OMNIDRIVE® 3in1 Handgrip
Slotted Screwdriver Bit 30mmL:	
1150	0.8 x 5.0 Slotted Screwdriver Bit
1160	1.0 x 6.0 Slotted Screwdriver Bit
1170	1.2 x 7.0 Slotted Screwdriver Bit
Philips Screwdriver Bit 30mmL:	
1101	#1 Philips Screwdriver Bit
1102	#2 Philips Screwdriver Bit
1103	#3 Philips Screwdriver Bit
Metric Wobble Hex Screwdriver Bit 30mmL:	
4133	3mm Wobble Hex Screwdriver Bit
4134	4mm Wobble Hex Screwdriver Bit
4135	5mm Wobble Hex Screwdriver Bit
4136	6mm Wobble Hex Screwdriver Bit
Metric Wobble Hex Screwdriver Bit 160mmL:	
4733	3mm Wobble Hex Screwdriver Bit
4734	4mm Wobble Hex Screwdriver Bit
4735	5mm Wobble Hex Screwdriver Bit
4736	6mm Wobble Hex Screwdriver Bit
4747	7mm Wobble Hex Screwdriver Bit
4748	8mm Wobble Hex Screwdriver Bit
Accessory:	
280002B	Socket Holder Adapter

 720 g CODE : 004370
 20 Sets / 15.5 Kgs / 0.73 CUFT



SB-219SWH 19 Piece SAE Wobble Hex Screwdriver Bit Set

Item No.	Description
280120	OMNIDRIVE® 3in1 Handgrip
Slotted Screwdriver Bit 30mmL:	
1150	0.8 x 5.0 Slotted Screwdriver Bit
1165	1.0 x 6.5 Slotted Screwdriver Bit
Philips Screwdriver Bit 30mmL:	
1101	#1 Philips Screwdriver Bit
1102	#2 Philips Screwdriver Bit
1103	#3 Philips Screwdriver Bit
SAE Wobble Hex Screwdriver Bit 30mmL:	
5108	1/8" Wobble Hex Screwdriver Bit
5110	5/32" Wobble Hex Screwdriver Bit
5112	3/16" Wobble Hex Screwdriver Bit
5114	7/32" Wobble Hex Screwdriver Bit
5116	1/4" Wobble Hex Screwdriver Bit
SAE Wobble Hex Screwdriver Bit 160mmL:	
5708	1/8" Wobble Hex Screwdriver Bit
5710	5/32" Wobble Hex Screwdriver Bit
5712	3/16" Wobble Hex Screwdriver Bit
5714	7/32" Wobble Hex Screwdriver Bit
5716	1/4" Wobble Hex Screwdriver Bit
5718	9/32" Wobble Hex Screwdriver Bit
5720	5/16" Wobble Hex Screwdriver Bit
Accessory:	
280002B	Socket Holder Adapter

 770 g CODE : 004800
 20 Sets / 16.5 Kgs / 0.73 CUFT

SB-225TO 25 Piece Star Screwdriver Bit Set

Item No.	Description
280120	OMNIDRIVE® 3in1 Handgrip
Star Screwdriver Bit 30mmL:	
6106	T-6 Star Screwdriver Bit
6107	T-7 Star Screwdriver Bit
6108	T-8 Star Screwdriver Bit
6109	T-9 Star Screwdriver Bit
6110	T-10 Star Screwdriver Bit
6115	T-15 Star Screwdriver Bit
6120	T-20 Star Screwdriver Bit
6125	T-25 Star Screwdriver Bit
6127	T-27 Star Screwdriver Bit
6130	T-30 Star Screwdriver Bit
6140	T-40 Star Screwdriver Bit
Star Screwdriver Bit 160mmL:	
6706	T-6 Star Screwdriver Bit
6707	T-7 Star Screwdriver Bit
6708	T-8 Star Screwdriver Bit
6709	T-9 Star Screwdriver Bit
6710	T-10 Star Screwdriver Bit
6715	T-15 Star Screwdriver Bit
6720	T-20 Star Screwdriver Bit
6725	T-25 Star Screwdriver Bit
6727	T-27 Star Screwdriver Bit
6730	T-30 Star Screwdriver Bit
6740	T-40 Star Screwdriver Bit
6745	T-45 Star Screwdriver Bit
6750	T-50 Star Screwdriver Bit

 1030 g CODE : 006440
 20 Sets / 21.5 Kgs / 0.73 CUFT



Screwdriver Bit Sets

SB-225RHM 25 Piece Hex & Square Screwdriver Bit Set

Item No.	Description
280120	OMNIDRIVE® 3in1 Handgrip
Metric Hex Screwdriver Bit 30mmL:	
2122	2mm Hex Screwdriver Bit
2125	2.5mm Hex Screwdriver Bit
2133	3mm Hex Screwdriver Bit
2134	4mm Hex Screwdriver Bit
2135	5mm Hex Screwdriver Bit
2136	6mm Hex Screwdriver Bit
Metric Hex Screwdriver Bit 160mmL:	
2722	2mm Hex Screwdriver Bit
2725	2.5mm Hex Screwdriver Bit
2733	3mm Hex Screwdriver Bit
2734	4mm Hex Screwdriver Bit
2735	5mm Hex Screwdriver Bit
2736	6mm Hex Screwdriver Bit
2747	7mm Hex Screwdriver Bit
2748	8mm Hex Screwdriver Bit
Square Screwdriver Bit 30mmL:	
9100	#0 Square Screwdriver Bit
9101	#1 Square Screwdriver Bit
9102	#2 Square Screwdriver Bit
9103	#3 Square Screwdriver Bit
9104	#4 Square Screwdriver Bit
Square Screwdriver Bit 160mmL:	
9700	#0 Square Screwdriver Bit
9701	#1 Square Screwdriver Bit
9702	#2 Square Screwdriver Bit
9703	#3 Square Screwdriver Bit
9704	#4 Square Screwdriver Bit
Kit Bag	

1040 g CODE : 006150
20 Sets / 22 Kgs / 0.73 CUFT



SB-225RHM

SB-227RHS 27 Piece Hex & Square Screwdriver Bit Set

Item No.	Description
280120	OMNIDRIVE® 3in1 Handgrip
SAE Hex Screwdriver Bit 30mmL:	
3106	3/32" Hex Screwdriver Bit
3108	1/8" Hex Screwdriver Bit
3110	5/32" Hex Screwdriver Bit
3112	3/16" Hex Screwdriver Bit
3114	7/32" Hex Screwdriver Bit
3116	1/4" Hex Screwdriver Bit
SAE Hex Screwdriver Bit 160mmL:	
3704	1/16" Hex Screwdriver Bit
3705	5/64" Hex Screwdriver Bit
3706	3/32" Hex Screwdriver Bit
3708	1/8" Hex Screwdriver Bit
3710	5/32" Hex Screwdriver Bit
3712	3/16" Hex Screwdriver Bit
3714	7/32" Hex Screwdriver Bit
3716	1/4" Hex Screwdriver Bit
3718	9/32" Hex Screwdriver Bit
3720	5/16" Hex Screwdriver Bit
Square Screwdriver Bit 30mmL:	
9100	#0 Square Screwdriver Bit
9101	#1 Square Screwdriver Bit
9102	#2 Square Screwdriver Bit
9103	#3 Square Screwdriver Bit
9104	#4 Square Screwdriver Bit
Square Screwdriver Bit 160mmL:	
9700	#0 Square Screwdriver Bit
9701	#1 Square Screwdriver Bit
9702	#2 Square Screwdriver Bit
9703	#3 Square Screwdriver Bit
9704	#4 Square Screwdriver Bit
Kit Bag	

1120 g CODE : 007180
20 Sets / 23.5 Kgs / 0.73 CUFT



SB-227RHS

SB-216TS 16 Piece Triple Square Screwdriver Bit Set

Item No.	Description
280120	OMNIDRIVE® 3in1 Handgrip
Slotted Screwdriver Bit 30mmL:	
1150	0.8 x 5.0 Slotted Screwdriver Bit
1160	1.0 x 6.0 Slotted Screwdriver Bit
1170	1.2 x 7.0 Slotted Screwdriver Bit
Phillips Screwdriver Bit 30mmL:	
1100	#0 Phillips Screwdriver Bit
1101	#1 Phillips Screwdriver Bit
1102	#2 Phillips Screwdriver Bit
1103	#3 Phillips Screwdriver Bit
Triple Square Screwdriver Bit 30mmL:	
8104	M4 Triple Square Screwdriver Bit
8105	M5 Triple Square Screwdriver Bit
8106	M6 Triple Square Screwdriver Bit
Triple Square Screwdriver Bit 160mmL:	
8704	M4 Triple Square Screwdriver Bit
8705	M5 Triple Square Screwdriver Bit
8706	M6 Triple Square Screwdriver Bit
8708	M8 Triple Square Screwdriver Bit

Accessory:
280002B Socket Holder Adapter
Kit Bag

610 g CODE : 003130
20 Sets / 13.5 Kgs / 0.73 CUFT

SB-224TOT 24 Piece Tamperproof Star Screwdriver Bit Set

Item No.	Description
280120	OMNIDRIVE® 3in1 Handgrip
Tamperproof Star Screwdriver Bit 30mmL:	
7107	T-7 Tamperproof Star Screwdriver Bit
7108	T-8 Tamperproof Star Screwdriver Bit
7109	T-9 Tamperproof Star Screwdriver Bit
7110	T-10 Tamperproof Star Screwdriver Bit
7115	T-15 Tamperproof Star Screwdriver Bit
7120	T-20 Tamperproof Star Screwdriver Bit
7125	T-25 Tamperproof Star Screwdriver Bit
7127	T-27 Tamperproof Star Screwdriver Bit
7130	T-30 Tamperproof Star Screwdriver Bit
7140	T-40 Tamperproof Star Screwdriver Bit
Tamperproof Star Screwdriver Bit 160mmL:	
7707	T-7 Tamperproof Star Screwdriver Bit
7708	T-8 Tamperproof Star Screwdriver Bit
7709	T-9 Tamperproof Star Screwdriver Bit
7710	T-10 Tamperproof Star Screwdriver Bit
7715	T-15 Tamperproof Star Screwdriver Bit
7720	T-20 Tamperproof Star Screwdriver Bit
7725	T-25 Tamperproof Star Screwdriver Bit
7727	T-27 Tamperproof Star Screwdriver Bit
7730	T-30 Tamperproof Star Screwdriver Bit
7740	T-40 Tamperproof Star Screwdriver Bit
7745	T-45 Tamperproof Star Screwdriver Bit
7750	T-50 Tamperproof Star Screwdriver Bit

Accessory:
280002B Socket Holder Adapter
Kit Bag

990 g CODE : 006990
20 Sets / 21 Kgs / 0.73 CUFT

SB-216TS



SB-224TOT

Screwdriver Bit Sets

SB-211MH 11 Piece Metric Hex & Triple Square Screwdriver Bit Set

Item No.	Description
Metric Hex Screwdriver Bit 30mmL:	
2122	2mm Hex Screwdriver Bit
2125	2.5mm Hex Screwdriver Bit
2133	3mm Hex Screwdriver Bit
2134	4mm Hex Screwdriver Bit
2135	5mm Hex Screwdriver Bit
2136	6mm Hex Screwdriver Bit
263070	7mm Hex Screwdriver Bit
263080	8mm Hex Screwdriver Bit
Triple Square Screwdriver Bit 30mmL:	
8104	M4 Triple Square Screwdriver Bit
8105	M5 Triple Square Screwdriver Bit
8106	M6 Triple Square Screwdriver Bit

Plastic Holder

 100 g CODE : 000610

 100 Sets / 11 Kgs / 0.6 CUFT

SB-111SP 11 Piece Slotted & Philips Screwdriver Bit S

Item No.	Description
Slotted Screwdriver Bit 30mmL:	
1130	0.5 x 3.0 Slotted Screwdriver Bit
1140	0.6 x 4.0 Slotted Screwdriver Bit
1150	0.8 x 5.0 Slotted Screwdriver Bit
1155	0.8 x 5.5 Slotted Screwdriver Bit
1160	1.0 x 6.0 Slotted Screwdriver Bit
1170	1.2 x 7.0 Slotted Screwdriver Bit
Philips Screwdriver Bit 30mmL:	
1100	#0 Philips Screwdriver Bit
1101	#1 Philips Screwdriver Bit
1102	#2 Philips Screwdriver Bit
1103	#3 Philips Screwdriver Bit

Accessory:

280002B Socket Holder Adapter

Plastic Holder

 100 g CODE : 000620

 100 Sets / 11 Kgs / 0.6 CUFT

SB-311SH 11 Piece SAE Hex Screwdriver Bit Set

Item No.	Description
SAE Hex Screwdriver Bit 30mmL:	
3104	1/16" Hex Screwdriver Bit
3105	5/64" Hex Screwdriver Bit
3106	3/32" Hex Screwdriver Bit
3107	7/64" Hex Screwdriver Bit
3108	1/8" Hex Screwdriver Bit
3110	5/32" Hex Screwdriver Bit
3112	3/16" Hex Screwdriver Bit
3114	7/32" Hex Screwdriver Bit
3116	1/4" Hex Screwdriver Bit
273009	9/32" Hex Screwdriver Bit
273010	5/16" Hex Screwdriver Bit

Plastic Holder

 100 g CODE : 000600

 100 Sets / 11 Kgs / 0.6 CUFT

SB-111SP



SB-211MH



SB-311SH



SB-711TP



SB-711TP 11 Piece Star Screwdriver Bit Set

Item No.	Description
Star Screwdriver Bit 30mmL:	
6106	T-6 Star Screwdriver Bit
6107	T-7 Star Screwdriver Bit
6108	T-8 Star Screwdriver Bit
6109	T-9 Star Screwdriver Bit
6110	T-10 Star Screwdriver Bit
6115	T-15 Star Screwdriver Bit
6120	T-20 Star Screwdriver Bit
6125	T-25 Star Screwdriver Bit
6127	T-27 Star Screwdriver Bit
6130	T-30 Star Screwdriver Bit
6140	T-40 Star Screwdriver Bit

Plastic Holder

 100 g CODE : 000580

 100 Sets / 11 Kgs / 0.6 CUFT

Screwdriver Bit Sets

SB-211MH 11 Piece Metric Hex & Triple Square Screwdriver Bit Set

Item No.	Description
Metric Hex Screwdriver Bit 30mmL:	
2122	2mm Hex Screwdriver Bit
2125	2.5mm Hex Screwdriver Bit
2133	3mm Hex Screwdriver Bit
2134	4mm Hex Screwdriver Bit
2135	5mm Hex Screwdriver Bit
2136	6mm Hex Screwdriver Bit
263070	7mm Hex Screwdriver Bit
263080	8mm Hex Screwdriver Bit
Triple Square Screwdriver Bit 30mmL:	
8104	M4 Triple Square Screwdriver Bit
8105	M5 Triple Square Screwdriver Bit
8106	M6 Triple Square Screwdriver Bit

Plastic Holder

 100 g CODE : 000610

 100 Sets / 11 Kgs / 0.6 CUFT

SB-111SP 11 Piece Slotted & Philips Screwdriver Bit S

Item No.	Description
Slotted Screwdriver Bit 30mmL:	
1130	0.5 x 3.0 Slotted Screwdriver Bit
1140	0.6 x 4.0 Slotted Screwdriver Bit
1150	0.8 x 5.0 Slotted Screwdriver Bit
1155	0.8 x 5.5 Slotted Screwdriver Bit
1160	1.0 x 6.0 Slotted Screwdriver Bit
1170	1.2 x 7.0 Slotted Screwdriver Bit
Philips Screwdriver Bit 30mmL:	
1100	#0 Philips Screwdriver Bit
1101	#1 Philips Screwdriver Bit
1102	#2 Philips Screwdriver Bit
1103	#3 Philips Screwdriver Bit

Accessory:

280002B Socket Holder Adapter

Plastic Holder

 100 g CODE : 000620

 100 Sets / 11 Kgs / 0.6 CUFT

SB-311SH 11 Piece SAE Hex Screwdriver Bit Set

Item No.	Description
SAE Hex Screwdriver Bit 30mmL:	
3104	1/16" Hex Screwdriver Bit
3105	5/64" Hex Screwdriver Bit
3106	3/32" Hex Screwdriver Bit
3107	7/64" Hex Screwdriver Bit
3108	1/8" Hex Screwdriver Bit
3110	5/32" Hex Screwdriver Bit
3112	3/16" Hex Screwdriver Bit
3114	7/32" Hex Screwdriver Bit
3116	1/4" Hex Screwdriver Bit
273009	9/32" Hex Screwdriver Bit
273010	5/16" Hex Screwdriver Bit

Plastic Holder

 100 g CODE : 000600

 100 Sets / 11 Kgs / 0.6 CUFT

SB-111SP



SB-211MH



SB-311SH



SB-711TP



SB-711TP 11 Piece Star Screwdriver Bit Set

Item No.	Description
Star Screwdriver Bit 30mmL:	
6106	T-6 Star Screwdriver Bit
6107	T-7 Star Screwdriver Bit
6108	T-8 Star Screwdriver Bit
6109	T-9 Star Screwdriver Bit
6110	T-10 Star Screwdriver Bit
6115	T-15 Star Screwdriver Bit
6120	T-20 Star Screwdriver Bit
6125	T-25 Star Screwdriver Bit
6127	T-27 Star Screwdriver Bit
6130	T-30 Star Screwdriver Bit
6140	T-40 Star Screwdriver Bit

Plastic Holder



 100 g CODE : 000580

 100 Sets / 11 Kgs / 0.6 CUFT

Impact Driver Sets



ID-314 14 Piece 3/8" Dr. Impact Driver Set

Item No.	Description
700007	3/8" Dr. Impact Driver
Slotted Screwdriver Bit 30mmL:	
1265	1.0 x 6.5 Slotted Screwdriver Bit
1280	1.2 x 8.0 Slotted Screwdriver Bit
1290	1.6 x 9.0 Slotted Screwdriver Bit
Slotted Screwdriver Bit 56mmL:	
1470	1.0 x 7.0 Slotted Screwdriver Bit
1480	1.2 x 8.0 Slotted Screwdriver Bit
1490	1.6 x 9.0 Slotted Screwdriver Bit
Phillips Screwdriver Bit 30mmL:	
1122	#2 Phillips Screwdriver Bit
1123	#3 Phillips Screwdriver Bit
1124	#4 Phillips Screwdriver Bit
Phillips Screwdriver Bit 56mmL:	
1402	#2 Phillips Screwdriver Bit
1403	#3 Phillips Screwdriver Bit
1404	#4 Phillips Screwdriver Bit
Accessory:	
363910	3/8" Dr. Bit Holder

Blow Case
 1360 g CODE : 004490
 12 Sets / 17.5 Kgs / 1.0 CUFT



ID-414 14 Piece 1/2" Dr. Impact Driver Set

Item No.	Description
700008	1/2" Dr. Impact Driver
Slotted Screwdriver Bit 30mmL:	
1265	1.0 x 6.5 Slotted Screwdriver Bit
1280	1.2 x 8.0 Slotted Screwdriver Bit
1290	1.6 x 9.0 Slotted Screwdriver Bit
Slotted Screwdriver Bit 56mmL:	
1470	1.0 x 7.0 Slotted Screwdriver Bit
1480	1.2 x 8.0 Slotted Screwdriver Bit
1490	1.6 x 9.0 Slotted Screwdriver Bit
Phillips Screwdriver Bit 30mmL:	
1122	#2 Phillips Screwdriver Bit
1123	#3 Phillips Screwdriver Bit
1124	#4 Phillips Screwdriver Bit
Phillips Screwdriver Bit 56mmL:	
1402	#2 Phillips Screwdriver Bit
1403	#3 Phillips Screwdriver Bit
1404	#4 Phillips Screwdriver Bit
Accessory:	
464110	1/2" Dr. Bit Holder

Blow Case
 1380 g CODE : 004560
 12 Sets / 17.5 Kgs / 1.0 CUFT



TG-406B 6 Piece 1/2" Dr. Impact Driver Set

Item No.	Description
700008	1/2" Dr. Impact Driver
5/16" Hex Shank Slotted Bit:	
700288	1.2 x 8.0 Slotted Screwdriver Bit
700290	1.6 x 10.0 Slotted Screwdriver Bit
5/16" Hex Shank Phillips Bit:	
700292	#2 Phillips Screwdriver Bit
700293	#3 Phillips Screwdriver Bit
Accessory:	
464110	1/2" Dr. 5/16" Hex Bit Holder

Metal Box
 1014 g CODE : 003800
 20 Sets / 22.5 Kgs / 0.64 CUFT



Impact Drivers



ITEM NO.	Drive	Length mm	Weight g	PCS 	G.W. KGS	CUFT 	CODE @
700007	3/8"	135	660	12	9.0	0.30	002915
700008	1/2"	138	670	12	10.0	0.30	002915



Torque Screwdriver Sets



TO-227L 27 Piece Lbf inch Torque Screwdriver Set

Item No.	Description
280045L	1/4" Dr. Torque Screwdriver 8~45 in. lbs.
Slotted Screwdriver Bit 30mmL:	
1160	1.0 x 6.0 Slotted Screwdriver Bit
1165	1.0 x 6.5 Slotted Screwdriver Bit
1170	1.2 x 7.0 Slotted Screwdriver Bit
Philips Screwdriver Bit 30mmL:	
1101	#1 Philips Screwdriver Bit
1102	#2 Philips Screwdriver Bit
1103	#3 Philips Screwdriver Bit
Metric Hex Screwdriver Bit 30mmL:	
2133	3mm Hex Screwdriver Bit
2134	4mm Hex Screwdriver Bit
2135	5mm Hex Screwdriver Bit
2136	6mm Hex Screwdriver Bit
SAE Hex Screwdriver Bit 30mmL:	
3108	1/8" Hex Screwdriver Bit
3110	5/32" Hex Screwdriver Bit
3112	3/16" Hex Screwdriver Bit
3114	7/32" Hex Screwdriver Bit
3116	1/4" Hex Screwdriver Bit
Tamperproof Star Screwdriver Bit 30mmL:	
7110	T-10 Tamperproof Star Screwdriver Bit
7115	T-15 Tamperproof Star Screwdriver Bit
7120	T-20 Tamperproof Star Screwdriver Bit
7125	T-25 Tamperproof Star Screwdriver Bit
7127	T-27 Tamperproof Star Screwdriver Bit
7130	T-30 Tamperproof Star Screwdriver Bit
7140	T-40 Tamperproof Star Screwdriver Bit
Triple Square Screwdriver Bit 30mmL:	
8104	M4 Triple Square Screwdriver Bit
8105	M5 Triple Square Screwdriver Bit
8106	M6 Triple Square Screwdriver Bit
Accessory:	
283508	1/4" Dr. 1/4" Hex Shank Bit Holder Blow Case

 750 g CODE : 012420
 25 Sets / 20 Kgs / 1.39 CUFT

TO-227N 27 Piece Nm Torque Screwdriver Set

Item No.	Description
280005N	1/4" Dr. Torque Screwdriver 0.5~5 Nm
Slotted Screwdriver Bit 30mmL:	
1160	1.0 x 6.0 Slotted Screwdriver Bit
1165	1.0 x 6.5 Slotted Screwdriver Bit
1170	1.2 x 7.0 Slotted Screwdriver Bit
Philips Screwdriver Bit 30mmL:	
1101	#1 Philips Screwdriver Bit
1102	#2 Philips Screwdriver Bit
1103	#3 Philips Screwdriver Bit
Metric Hex Screwdriver Bit 30mmL:	
2133	3mm Hex Screwdriver Bit
2134	4mm Hex Screwdriver Bit
2135	5mm Hex Screwdriver Bit
2136	6mm Hex Screwdriver Bit
SAE Hex Screwdriver Bit 30mmL:	
3108	1/8" Hex Screwdriver Bit
3110	5/32" Hex Screwdriver Bit
3112	3/16" Hex Screwdriver Bit
3114	7/32" Hex Screwdriver Bit
3116	1/4" Hex Screwdriver Bit
Tamperproof Star Screwdriver Bit 30mmL:	
7110	T-10 Tamperproof Star Screwdriver Bit
7115	T-15 Tamperproof Star Screwdriver Bit
7120	T-20 Tamperproof Star Screwdriver Bit
7125	T-25 Tamperproof Star Screwdriver Bit
7127	T-27 Tamperproof Star Screwdriver Bit
7130	T-30 Tamperproof Star Screwdriver Bit
7140	T-40 Tamperproof Star Screwdriver Bit
Triple Square Screwdriver Bit 30mmL:	
8104	M4 Triple Square Screwdriver Bit
8105	M5 Triple Square Screwdriver Bit
8106	M6 Triple Square Screwdriver Bit
Accessory:	
283508	1/4" Dr. 1/4" Hex Shank Bit Holder Blow Case



 750 g CODE : 012420
 25 Sets / 20 Kgs / 1.39 CUFT

TO-227L
(TO-227N)





Screwdrivers

Slotted Screwdrivers

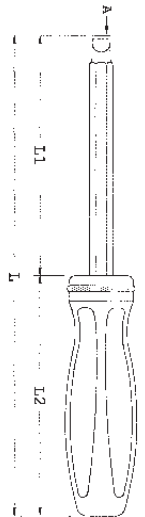
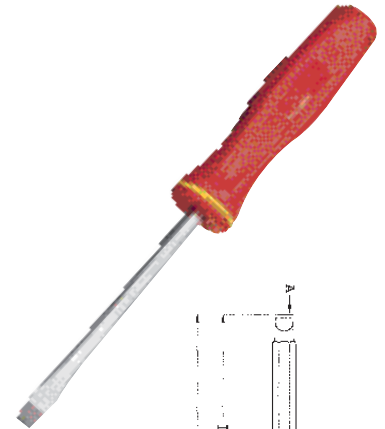
ITEM NO.	H x W mm	Length mm	L1 mm	L2 mm	Weight g	PCS 	G.W. KGS	CUFT 	CODE @
592+1230	0.5 x 3.0	150	75	75	30	320	11.0	1.60	000350
* 593+1230	0.5 x 3.0	170	75	95	45	320	15.5	1.60	000430
592+1240	0.8 x 4.0	175	100	75	35	200	8.0	1.60	000400
* 593+1240	0.8 x 4.0	195	100	95	50	200	11.0	1.60	000480
593+1250	0.8 x 5.0	345	250	95	90	200	19.0	2.58	000650
* 594+1250	0.8 x 5.0	360	250	110	100	200	21.0	2.58	000700
593+1455	1.0 x 5.5	195	100	95	65	200	14.0	1.60	000480
* 594+1455	1.0 x 5.5	210	100	110	75	200	16.0	1.60	000530
593+1457	1.0 x 5.5	245	150	95	75	200	16.0	1.97	000520
* 594+1457	1.0 x 5.5	260	150	110	85	200	18.0	1.97	000570
593+1965	1.2 x 6.5	195	100	95	85	200	18.0	1.60	000500
* 594+1965	1.2 x 6.5	210	100	110	95	200	20.0	1.60	000550
593+1966	1.2 x 6.5	245	150	95	100	200	21.0	1.97	000540
* 594+1966	1.2 x 6.5	260	150	110	110	200	23.0	1.97	000590
593+1967	1.2 x 6.5	295	200	95	110	200	23.0	2.64	000620
* 594+1967	1.2 x 6.5	310	200	110	120	200	25.0	2.64	000670
594+1980	1.2 x 8.0	285	175	110	155	60	10.5	2.06	000700
* 595+1980	1.2 x 8.0	295	175	120	170	60	11.5	2.06	000750
594+1990	1.6 x 10.0	310	200	110	230	60	15.0	2.06	000750
* 595+1990	1.6 x 10.0	320	200	120	245	60	16.0	2.06	000800
594+1991	1.6 x 10.0	360	250	110	265	60	17.0	2.06	000800
* 595+1991	1.6 x 10.0	370	250	120	280	60	18.0	2.06	000850
595+1992	2.0 x 12.0	320	200	120	335	60	21.0	2.06	000880
* 596+1992	2.0 x 12.0	340	200	140	350	60	22.0	2.06	000990
595+1994	2.5 x 14.0	370	250	120	385	40	16.5	1.13	001050
* 596+1994	2.5 x 14.0	390	250	140	400	40	17.0	1.13	001160
591+1465	1.2 x 6.5	86	38	48	40	200	9.0	1.39	000350



Philips Screwdrivers

ITEM NO.	Size	Length mm	L1 mm	L2 mm	Weight g	PCS 	G.W. KGS	CUFT 	CODE @
592+1400	#0	150	75	75	35	320	12.5	1.60	000350
* 593+1400	#0	170	75	95	45	320	15.5	1.60	000430
593+1401	#1	170	75	95	65	200	14.0	1.60	000400
* 594+1401	#1	185	75	110	75	200	16.0	1.60	000450
593+1421	#1	195	100	95	70	200	15.0	1.60	000450
* 594+1421	#1	210	100	110	80	200	17.0	1.60	000500
593+1431	#1	345	250	95	90	200	19.0	2.85	000600
* 594+1431	#1	360	250	110	100	200	21.0	2.85	000650
593+1602	#2	140	45	95	70	200	15.0	1.60	000400
* 594+1602	#2	155	45	110	80	200	17.0	1.60	000450
* 594+1712	#2	210	100	110	95	160	16.5	1.97	000520
593+1802	#2	220	125	95	90	160	15.5	1.97	000500
* 594+1802	#2	235	125	110	100	160	17.0	1.97	000550
* 594+1812	#2	260	150	110	105	200	22.0	2.64	000620
593+1902	#2	295	200	95	110	200	23.0	2.64	000600
* 594+1902	#2	310	200	110	120	200	25.0	2.64	000650
593+1932	#2	395	300	95	140	50	8.0	1.13	000700
* 594+1932	#2	410	300	110	150	50	8.5	1.13	000750
594+1913	#3	235	125	110	140	160	23.5	1.97	000650
* 595+1913	#3	245	125	120	155	160	26.0	1.97	000700
* 595+1843	#3	270	150	120	165	60	11.0	2.06	000730
594+1923	#3	310	200	110	165	60	11.0	2.06	000700
* 595+1923	#3	320	200	120	180	60	12.0	2.06	000750
594+1933	#3	380	270	110	200	50	11.0	1.13	000850
* 595+1933	#3	390	270	120	215	50	12.0	1.13	000900
594+1924	#4	310	200	110	235	60	15.0	2.06	000850
* 595+1924	#4	320	200	120	245	60	16.0	2.06	000900
591+1201	#1	86	38	48	40	200	9.0	1.93	000350

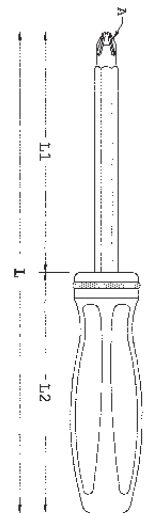
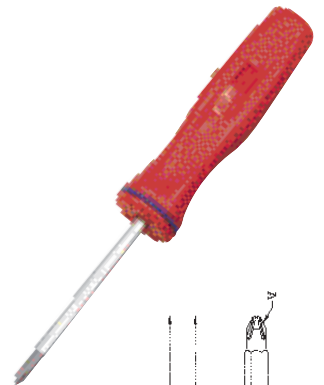

* with large handle

Hex bolster on every screwdrivers lets you generate extra turning power with a wrench.

Screwdriver Sets

TL-518 18 Piece Combination Screwdriver Set

Item No. Description

Micro-Tech Screwdriver:

5602070	2.0 Slotted Screwdriver
5602570	2.5 Slotted Screwdriver
5603070	3.0 Slotted Screwdriver
570071	#000 Phillips Screwdriver
570072	#00 Phillips Screwdriver
570073	#0 Phillips Screwdriver

Slotted Screwdriver:

593 + 1250	0.8 x 5.0mm Slotted Screwdriver 345mmL
591 + 1465	1.2 x 6.5mm Slotted Screwdriver 86mmL
593 + 1965	1.2 x 6.5mm Slotted Screwdriver 195mmL
594 + 1990	1.6 x 10.0mm Slotted Screwdriver 310mmL
594 + 1991	1.6 x 10.0mm Slotted Screwdriver 360mmL

Phillips Screwdriver:

591 + 1201	#1 Phillips Screwdriver 86mmL
593 + 1401	#1 Phillips Screwdriver 170mmL
593 + 1431	#1 Phillips Screwdriver 345mmL
593 + 1602	#2 Phillips Screwdriver 140mmL
593 + 1902	#2 Phillips Screwdriver 295mmL
593 + 1932	#2 Phillips Screwdriver 395mmL
594 + 1923	#3 Phillips Screwdriver 310mmL

Blow Case

2360 g CODE : 007600

10 Sets / 24.5 Kgs / 3.60 CUFT

TL-515X 15 Piece Combination Screwdriver & Pry Bar Set

Item No. Description

Slotted Screwdriver:

593 + 1230	0.5 x 3.0mm Slotted Screwdriver 170mmL
594 + 1250	0.8 x 5.0mm Slotted Screwdriver 360mmL
594 + 1965	1.2 x 6.5mm Slotted Screwdriver 210mmL
595 + 1980	1.2 x 8.0mm Slotted Screwdriver 295mmL
595 + 1990	1.6 x 10.0mm Slotted Screwdriver 320mmL
591 + 1465	1.2 x 6.5mm Slotted Screwdriver 86mmL

Phillips Screwdriver:

593 + 1400	#0 Phillips Screwdriver 170mmL
594 + 1401	#1 Phillips Screwdriver 185mmL
594 + 1431	#1 Phillips Screwdriver 360mmL
594 + 1602	#2 Phillips Screwdriver 155mmL
594 + 1802	#2 Phillips Screwdriver 235mmL
594 + 1902	#2 Phillips Screwdriver 310mmL
595 + 1923	#3 Phillips Screwdriver 320mmL
591 + 1201	#1 Phillips Screwdriver 86mmL

Pry Bar:

595 + 9912	300mmL (12") Bent Tip Pry Bar
------------	-------------------------------

Blow Case

2380 g CODE : 008250

8 Sets / 20 Kgs / 2.6 CUFT

TL-517X 17 Piece Combination Screwdriver Set

Item No. Description

Slotted Screwdriver:

593 + 1230	0.5 x 3.0mm Slotted Screwdriver 170mmL
594 + 1250	0.8 x 5.0mm Slotted Screwdriver 360mmL
594 + 1965	1.2 x 6.5mm Slotted Screwdriver 210mmL
595 + 1980	1.2 x 8.0mm Slotted Screwdriver 295mmL
595 + 1990	1.6 x 10.0mm Slotted Screwdriver 320mmL
591 + 1465	1.2 x 6.5mm Slotted Screwdriver 86mmL

Phillips Screwdriver:

593 + 1400	#0 Phillips Screwdriver 170mmL
594 + 1401	#1 Phillips Screwdriver 185mmL
594 + 1431	#1 Phillips Screwdriver 360mmL
594 + 1602	#2 Phillips Screwdriver 155mmL
594 + 1712	#2 Phillips Screwdriver 210mmL
594 + 1802	#2 Phillips Screwdriver 235mmL
594 + 1812	#2 Phillips Screwdriver 260mmL
594 + 1902	#2 Phillips Screwdriver 310mmL
595 + 1843	#3 Phillips Screwdriver 270mmL
595 + 1923	#3 Phillips Screwdriver 320mmL
591 + 1201	#1 Phillips Screwdriver 86mmL

Blow Case

2500 g CODE : 008730

8 Sets / 21 Kgs / 2.6 CUFT

TL-508 8 Piece Combination Screwdriver Set

Item No. Description

Slotted Screwdriver:

591 + 1465	1.2 x 6.5mm Slotted Screwdriver 86mmL
593 + 1965	1.2 x 6.5mm Slotted Screwdriver 195mmL
594 + 1980	1.2 x 8.0mm Slotted Screwdriver 285mmL
594 + 1990	1.6 x 10.0mm Slotted Screwdriver 310mmL

Phillips Screwdriver:

591 + 1201	#1 Phillips Screwdriver 86mmL
593 + 1401	#1 Phillips Screwdriver 170mmL
593 + 1802	#2 Phillips Screwdriver 220mmL
593 + 1902	#2 Phillips Screwdriver 295mmL

Blow Case

1285 g CODE : 003800

20 Sets / 27 Kgs / 3.60 CUFT

TL-515X



TL-517X



TL-518

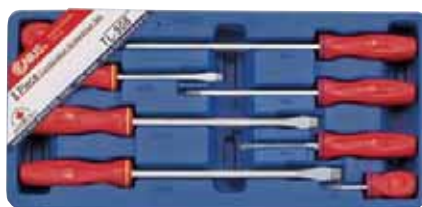

TL-508

Screwdrivers

4-in-1

508003 4in1 Screwdriver

Item No. Description

Double Ended Tip Bit:

267512 #1 & #2 Philips Bit

267560 0.8x5.0 & 1.0x6.0mm Slotted Bit

Slide Card

 170 g CODE : 001360

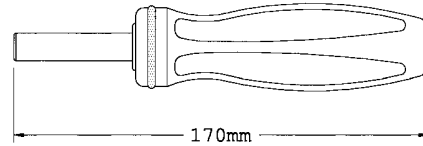
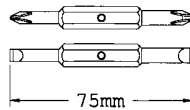

 120 Sets / 24 Kgs / 1.94 CUFT



508003



Hex Screwdrivers

ITEM NO.	Size	Length mm	L1 mm	L2 mm	Weight g	PCS 	G.W. KGS	CUFT 	CODE @
592+2622	2mm	145	70	75	50	200	11.0	1.60	000400
592+2625	2.5mm	145	70	75	50	200	11.0	1.60	000400
592+2633	3mm	145	70	75	50	200	11.0	1.60	000400
592+2634	4mm	145	70	75	50	200	11.0	1.60	000400
593+2735	5mm	180	85	95	80	200	17.0	1.60	000560
593+2736	6mm	180	85	95	80	200	17.0	1.60	000560
594+2847	7mm	225	115	110	125	100	13.5	2.06	000830
594+2848	8mm	225	115	110	125	100	13.5	2.06	000830
595+2849	9mm	225	105	120	170	80	15.0	2.06	001080
595+2850	10mm	225	105	120	190	80	16.5	2.06	001080
592+3604	1/16"	145	70	75	50	200	11.0	1.60	000400
592+3605	5/64"	145	70	75	50	200	11.0	1.60	000400
592+3606	3/32"	145	70	75	50	200	11.0	1.60	000400
592+3607	7/64"	145	70	75	50	200	11.0	1.60	000400
592+3608	1/8"	145	70	75	50	200	11.0	1.60	000400
592+3610	5/32"	145	70	75	50	200	11.0	1.60	000400
593+3712	3/16"	180	85	95	80	200	17.0	1.60	000560
593+3714	7/32"	180	85	95	80	200	17.0	1.60	000560
594+3816	1/4"	225	115	110	100	100	11.0	2.06	000680
594+3818	9/32"	225	115	110	125	100	13.5	2.06	000830
594+3820	5/16"	225	115	110	125	100	13.5	2.06	000830
595+3824	3/8"	225	105	120	190	80	16.5	2.06	001080

Wobble Hex Screwdrivers

ITEM NO.	Size	Length mm	L1 mm	L1 mm	Weight g	PCS 	G.W. KGS	CUFT 	CODE @
592+4633	3mm	145	70	75	50	200	11.0	1.60	000450
592+4634	4mm	145	70	75	50	200	11.0	1.60	000450
593+4735	5mm	180	85	95	80	200	17.0	1.60	000610
593+4736	6mm	180	85	95	80	200	17.0	1.60	000610
594+4847	7mm	225	115	110	125	100	13.5	2.06	000890
594+4848	8mm	225	115	110	125	100	13.5	2.06	000890
595+4849	9mm	225	105	120	170	80	15.0	2.06	001140
595+4850	10mm	225	105	120	190	80	16.5	2.06	001140
592+5608	1/8"	145	70	75	50	200	11.0	1.60	000450
592+5610	5/32"	145	70	75	50	200	11.0	1.60	000450
593+5712	3/16"	180	85	95	80	200	17.0	1.60	000610
593+5714	7/32"	180	85	95	80	200	17.0	1.60	000610
594+5816	1/4"	225	115	110	100	100	11.0	2.06	000740
594+5818	9/32"	225	115	110	125	100	13.5	2.06	000890
594+5820	5/16"	225	115	110	125	100	13.5	2.06	000890
595+5824	3/8"	225	105	120	180	80	15.5	2.06	001140



Screwdriver Sets

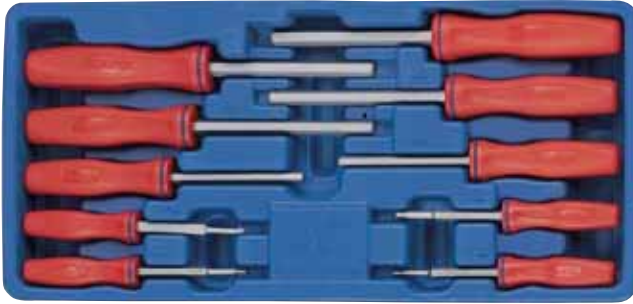

HS-5610M

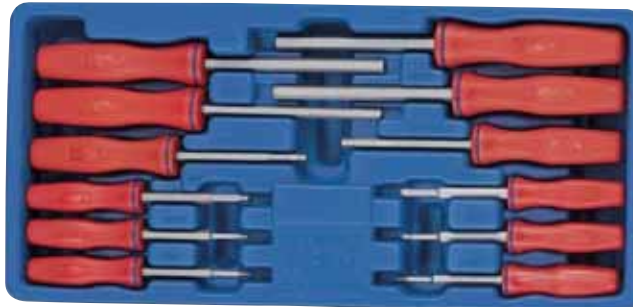

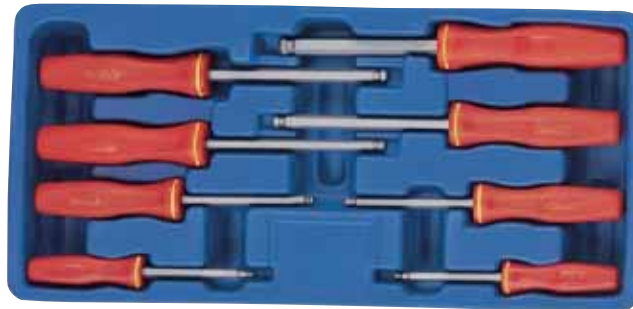

HS-5612S



**HS-5708MW
(HS-5708SW)**



HS-5708MW 8 Piece Metric Wobble Hex Screwdriver Set

Item No.	Description
Metric Wobble Hex Screwdriver:	
592 + 4633	3mm Wobble Hex Screwdriver 145mmL
592 + 4634	4mm Wobble Hex Screwdriver 145mmL
593 + 4735	5mm Wobble Hex Screwdriver 180mmL
593 + 4736	6mm Wobble Hex Screwdriver 180mmL
594 + 4847	7mm Wobble Hex Screwdriver 225mmL
594 + 4848	8mm Wobble Hex Screwdriver 225mmL
595 + 4849	9mm Wobble Hex Screwdriver 225mmL
595 + 4850	10mm Wobble Hex Screwdriver 225mmL

 1370 g CODE : 005870
 5 Sets / 7.9 Kgs / 0.93 CUFT

HS-5610M 10 Piece Metric Hex Screwdriver Set

Item No.	Description
Metric Hex Screwdriver:	
592 + 2622	2mm Hex Screwdriver 145mmL
592 + 2625	2.5mm Hex Screwdriver 145mmL
592 + 2633	3mm Hex Screwdriver 145mmL
592 + 2634	4mm Hex Screwdriver 145mmL
593 + 2735	5mm Hex Screwdriver 180mmL
593 + 2736	6mm Hex Screwdriver 180mmL
594 + 2847	7mm Hex Screwdriver 225mmL
594 + 2848	8mm Hex Screwdriver 225mmL
595 + 2849	9mm Hex Screwdriver 225mmL
595 + 2850	10mm Hex Screwdriver 225mmL

 1470 g CODE : 006200
 5 Sets / 8.4 Kgs / 0.93 CUFT



HS-5612S 12 Piece SAE Hex Screwdriver Set

Item No.	Description
SAE Hex Screwdriver:	
592 + 3604	1/16" Hex Screwdriver 145mmL
592 + 3605	5/64" Hex Screwdriver 145mmL
592 + 3606	3/32" Hex Screwdriver 145mmL
592 + 3607	7/64" Hex Screwdriver 145mmL
592 + 3608	1/8" Hex Screwdriver 145mmL
592 + 3610	5/32" Hex Screwdriver 145mmL
593 + 3712	3/16" Hex Screwdriver 180mmL
593 + 3714	7/32" Hex Screwdriver 180mmL
594 + 3816	1/4" Hex Screwdriver 225mmL
594 + 3818	9/32" Hex Screwdriver 225mmL
594 + 3820	5/16" Hex Screwdriver 225mmL
595 + 3824	3/8" Hex Screwdriver 225mmL



 1500 g CODE : 006590
 5 Sets / 8.5 Kgs / 0.93 CUFT

HS-5708SW 8 Piece SAE Wobble Hex Screwdriver Set



Item No.	Description
SAE Wobble Hex Screwdriver:	
592 + 5608	1/8" Wobble Hex Screwdriver 145mmL
592 + 5610	5/32" Wobble Hex Screwdriver 145mmL
593 + 5712	3/16" Wobble Hex Screwdriver 180mmL
593 + 5714	7/32" Wobble Hex Screwdriver 180mmL
594 + 5816	1/4" Wobble Hex Screwdriver 225mmL
594 + 5818	9/32" Wobble Hex Screwdriver 225mmL
594 + 5820	5/16" Wobble Hex Screwdriver 225mmL
595 + 5824	3/8" Wobble Hex Screwdriver 225mmL

 1290 g CODE : 005490
 5 Sets / 7.5 Kgs / 0.93 CUFT

Star Screwdrivers

ITEM NO.	Size	L1 mm	L2 mm	Length mm	Weight g	PCS 	G.W. KGS	CUFT 	CODE @
592 + 6606	T-6	70	75	145	50	200	11.0	1.60	000400
592 + 6607	T-7	70	75	145	50	200	11.0	1.60	000400
592 + 6608	T-8	70	75	145	50	200	11.0	1.60	000400
592 + 6609	T-9	70	75	145	50	200	11.0	1.60	000400
593 + 6710	T-10	80	95	175	80	200	17.0	1.60	000560
593 + 6715	T-15	80	95	175	80	200	17.0	1.60	000560
593 + 6720	T-20	80	95	175	80	200	17.0	1.60	000560
593 + 6725	T-25	80	95	175	80	200	17.0	1.60	000560
594 + 6827	T-27	105	110	215	100	100	11.0	2.06	000680
594 + 6830	T-30	105	110	215	100	100	11.0	2.06	000680
595 + 6840	T-40	105	120	225	115	80	10.5	2.06	000730
595 + 6845	T-45	105	120	225	135	80	11.0	2.06	000880
595 + 6850	T-50	105	120	225	185	80	15.0	2.06	000880

Tamperproof Star Screwdrivers

ITEM NO.	Size	L1 mm	L2 mm	Length mm	Weight g	PCS 	G.W. KGS	CUFT 	CODE @
592 + 7606	T-6	70	75	145	50	200	11.0	1.60	000450
592 + 7607	T-7	70	75	145	50	200	11.0	1.60	000450
592 + 7608	T-8	70	75	145	50	200	11.0	1.60	000450
592 + 7609	T-9	70	75	145	50	200	11.0	1.60	000450
593 + 7710	T-10	80	95	175	80	200	17.0	1.60	000580
593 + 7715	T-15	80	95	175	80	200	17.0	1.60	000580
593 + 7920	T-20	100	95	195	85	200	18.0	1.60	000630
593 + 7925	T-25	100	95	195	85	200	18.0	1.60	000630
594 + 7827	T-27	105	110	215	100	100	11.0	2.06	000740
594 + 7830	T-30	105	110	215	100	100	11.0	2.06	000740
595 + 7940	T-40	130	120	250	120	80	11.0	2.06	000870
595 + 7945	T-45	130	120	250	150	80	13.0	2.06	001040
595 + 7850	T-50	105	120	225	140	80	12.0	2.06	000940

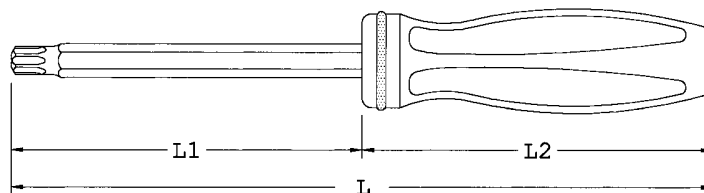

Screwdriver Sets

TX-513T 13 Piece Star Screwdriver Set

Item No.	Description
Star Screwdriver:	
592 + 6606	T-6 Star Screwdriver 145mmL
592 + 6607	T-7 Star Screwdriver 145mmL
592 + 6608	T-8 Star Screwdriver 145mmL
592 + 6609	T-9 Star Screwdriver 145mmL
593 + 6710	T-10 Star Screwdriver 175mmL
593 + 6715	T-15 Star Screwdriver 175mmL
593 + 6720	T-20 Star Screwdriver 175mmL
593 + 6725	T-25 Star Screwdriver 175mmL
594 + 6827	T-27 Star Screwdriver 215mmL
594 + 6830	T-30 Star Screwdriver 215mmL
595 + 6840	T-40 Star Screwdriver 225mmL
595 + 6845	T-45 Star Screwdriver 225mmL
595 + 6850	T-50 Star Screwdriver 225mmL

Blow Case

⚖️ 1750 g CODE : 006150

📦 4 Sets / 8 Kgs / 1.07 CUFT

TX-512A 12 Piece Tamperproof Star Screwdriver Set

Item No.	Description
Tamperproof Star Screwdriver:	
592 + 7606	T-6 Tamperproof Star Screwdriver 145mmL
592 + 7607	T-7 Tamperproof Star Screwdriver 145mmL
592 + 7608	T-8 Tamperproof Star Screwdriver 145mmL
592 + 7609	T-9 Tamperproof Star Screwdriver 145mmL
593 + 7710	T-10 Tamperproof Star Screwdriver 175mmL
593 + 7715	T-15 Tamperproof Star Screwdriver 175mmL
593 + 7920	T-20 Tamperproof Star Screwdriver 195mmL
593 + 7925	T-25 Tamperproof Star Screwdriver 195mmL
594 + 7827	T-27 Tamperproof Star Screwdriver 215mmL
594 + 7830	T-30 Tamperproof Star Screwdriver 215mmL
595 + 7940	T-40 Tamperproof Star Screwdriver 250mmL
595 + 7945	T-45 Tamperproof Star Screwdriver 250mmL

⚖️ 1400 g

CODE : 005800

📦 10 Sets / 15 Kgs / 1.58 CUFT



TX-513T

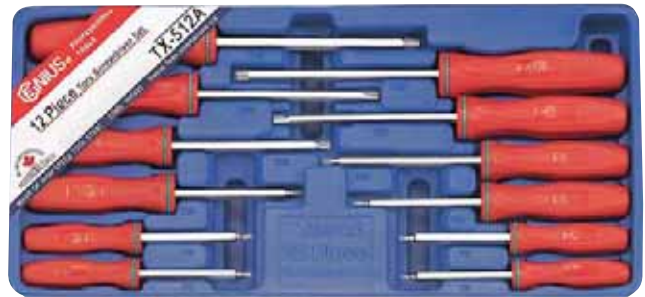

TX-512A



Square Screwdrivers

ITEM NO.	Size	L1 mm	Length mm	Weight g	PCS 	G.W. KGS	CUFT 	CODE @
500050	#0	100	195	70	120	9.5	1.96	000435
500051	#1	100	195	70	120	9.5	1.96	000435
500052	#2	100	210	100	120	13.0	1.96	000545
500053	#3	100	210	100	120	13.0	1.96	000545
500054	#4	100	210	120	120	15.5	1.96	000655



TL-504A 4 Piece Square Screwdriver Set

Item No. Description

Square Screwdriver:

500050 #0 Square Screwdriver 195mmL

500051 #1 Square Screwdriver 195mmL

500052 #2 Square Screwdriver 210mmL

500053 #3 Square Screwdriver 210mmL

Slide Card

 400 g CODE : 001862

 24 Sets / 20.5 Kgs / 1.96 CUFT

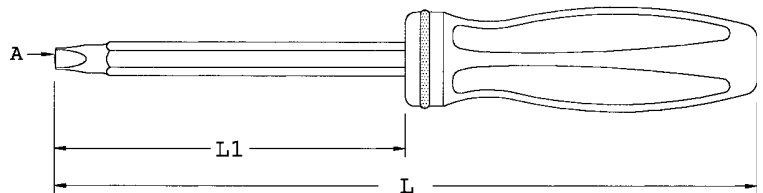

TL-504A



Screwdriver Sets



Micro-Tech Slotted Screwdrivers

ITEM NO.	Size mm	L1 mm	L2 mm	Length mm	Weight g	PCS 	G.W. KGS	CUFT 	CODE @
5601270	0.3 x 1.2	40	82	122	12	150	3.0	0.52	000280
5601670	0.3 x 1.6	40	82	122	12	150	3.0	0.52	000280
5602070	0.4 x 2.0	40	82	122	12	150	3.0	0.52	000280
5602570	0.4 x 2.5	40	82	122	12	150	3.0	0.52	000280
5603070	0.5 x 3.0	40	82	122	12	150	3.0	0.52	000280
561512	0.3 x 1.2	73	82	150	14	100	2.5	0.62	000320
561516	0.3 x 1.6	73	82	150	14	100	2.5	0.62	000320
561520	0.4 x 2.0	73	82	150	14	100	2.5	0.62	000320
561525	0.4 x 2.5	73	82	150	14	100	2.5	0.62	000320
561530	0.5 x 3.0	73	82	150	14	100	2.5	0.62	000320

Micro-Tech Philips Screwdrivers

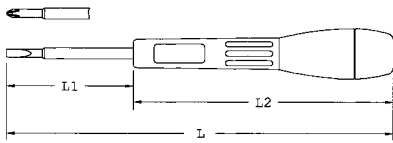

ITEM NO.	Size	L1 mm	L2 mm	Length mm	Weight g	PCS 	G.W. KGS	CUFT 	CODE @
570071	#000	40	82	122	12	150	3.0	0.52	000280
570072	#00	40	82	122	12	150	3.0	0.52	000280
570073	#0	40	82	122	12	150	3.0	0.52	000280
571571	#000	73	82	150	14	100	2.5	0.62	000320
571572	#00	73	82	150	14	100	2.5	0.62	000320
571573	#0	73	82	150	14	100	2.5	0.62	000320

TL-506 6 Piece Micro-Tech Screwdriver Set

Item No.	Description
5602070	0.4 x 2.0 Slotted Screwdriver
5602570	0.4 x 2.5 Slotted Screwdriver
5603070	0.5 x 3.0 Slotted Screwdriver
570071	#000 Philips Screwdriver
570072	#00 Philips Screwdriver
570073	#0 Philips Screwdriver

Plastic Case

160 g CODE : 001650
 40 Sets / 7.5 Kgs / 0.73 CUFT

TL-506A 6 Piece Micro-Tech Screwdriver Set

Item No.	Description
5601270	0.3 x 1.2 Slotted Screwdriver
5601670	0.3 x 1.6 Slotted Screwdriver
5602070	0.4 x 2.0 Slotted Screwdriver
570071	#000 Philips Screwdriver
570072	#00 Philips Screwdriver
570073	#0 Philips Screwdriver

Plastic Case

160 g CODE : 001650
 40 Sets / 7.5 Kgs / 0.73 CUFT

MT-508 6 Piece Micro-Tech Screwdriver Set

Item No.	Description
Micro-Tech Slotted Screwdriver:	
5601270	0.3 x 1.2 Slotted Screwdriver
5601670	0.3 x 1.6 Slotted Screwdriver
5602070	0.4 x 2.0 Slotted Screwdriver
5602570	0.4 x 2.5 Slotted Screwdriver
5603070	0.5 x 3.0 Slotted Screwdriver

Micro-Tech Philips Screwdriver:

570071	#000 Philips Screwdriver
570072	#00 Philips Screwdriver
570073	#0 Philips Screwdriver

Plastic Case

185 g CODE : 002130
 40 Sets / 8.5 Kgs / 0.73 CUFT



TL-506
(TL-506A)



MT-508

MT-508L

MT-508L 6 Piece Micro-Tech Screwdriver Set

Item No.	Description
Micro-Tech Slotted Screwdriver:	
561512	0.3 x 1.2 Slotted Screwdriver
561516	0.3 x 1.6 Slotted Screwdriver
561520	0.4 x 2.0 Slotted Screwdriver
561525	0.4 x 2.5 Slotted Screwdriver
561530	0.5 x 3.0 Slotted Screwdriver



Micro-Tech Philips Screwdriver:

571571	#000 Philips Screwdriver
571572	#00 Philips Screwdriver
571573	#0 Philips Screwdriver



Plastic Case

200 g CODE : 002430
 40 Sets / 9.0 Kgs / 0.73 CUFT



Metric Hex Nut Drivers

ITEM NO.	Size mm	L2 mm	L1 mm	Length mm	Weight g	PCS 	G.W. KGS	CUFT 	CODE @
593744	4	4	70	165	75	200	16.0	1.60	000640
593745	5	7	70	165	75	200	16.0	1.60	000640
593755	5.5	7	70	165	75	200	16.0	1.60	000640
593756	6	8	70	165	75	200	16.0	1.60	000640
594757	7	9	70	180	90	160	15.5	1.60	000690
594758	8	9	70	180	90	160	15.5	1.60	000690
594759	9	10	70	180	90	160	15.5	1.60	000690
594760	10	11	70	180	90	160	15.5	1.60	000690
594761	11	11	70	180	90	160	15.5	1.60	000690
594762	12	12	70	180	90	160	15.5	1.60	000690
595763	13	13	70	190	130	120	17.0	1.60	000840
595764	14	14	70	190	130	120	17.0	1.60	000840



SAE Hex Nut Drivers

ITEM NO.	Size Inch	L2 mm	L1 mm	Length mm	Weight g	PCS 	G.W. KGS	CUFT 	CODE @
593712	3/16	5	70	165	75	200	16.0	1.60	000640
593716	1/4	6	70	165	75	200	16.0	1.60	000640
594720	5/16	8	70	180	90	160	15.5	1.60	000690
594722	11/32	9	70	180	90	160	15.5	1.60	000690
594724	3/8	10	70	180	90	160	15.5	1.60	000690
594728	7/16	12	70	180	90	160	15.5	1.60	000690
595732	1/2	14	70	190	130	120	17.0	1.60	000840

Metric Long Hex Nut Drivers

ITEM NO.	Size mm	L2 mm	L1 mm	Length mm	Weight g	PCS 	G.W. KGS	CUFT 	CODE @
593844	4	4	150	245	95	200	20.0	1.97	000890
593845	5	7	150	245	95	200	20.0	1.97	000890
593855	5.5	7	150	245	95	200	20.0	1.97	000890
593856	6	8	150	245	95	200	20.0	1.97	000890
594857	7	9	150	260	120	160	20.5	1.97	000940
594858	8	9	150	260	120	160	20.5	1.97	000940
594859	9	10	150	260	120	160	20.5	1.97	000940
594860	10	11	150	260	120	160	20.5	1.97	000940
594861	11	11	150	260	120	160	20.5	1.97	000940
594862	12	12	150	260	120	160	20.5	1.97	000940
595863	13	13	150	270	160	120	20.5	1.97	001140
595864	14	14	150	270	160	120	20.5	1.97	001140

SAE Long Hex Nut Drivers

ITEM NO.	Size Inch	L2 mm	L1 mm	Length mm	Weight g	PCS 	G.W. KGS	CUFT 	CODE @
593812	3/16	5	150	245	95	200	20.0	1.97	000890
593816	1/4	6	150	245	95	200	20.0	1.97	000890
594820	5/16	8	150	260	120	160	20.5	1.97	000940
594822	11/32	10	150	260	120	160	20.5	1.97	000940
594824	3/8	10	150	260	120	160	20.5	1.97	000940
594828	7/16	12	150	260	120	160	20.5	1.97	000940
595832	1/2	14	150	270	160	120	20.5	1.97	001140

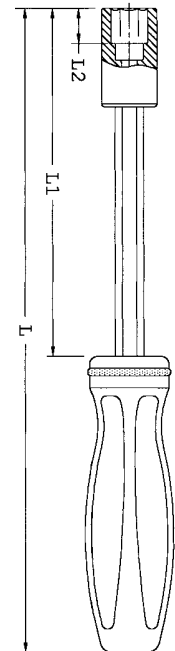

Screwdriver Sets



ND-012M

ND-012M 12 Piece Metric Hex Nut Driver Set

Item No.	Description
Metric Hex Nut Driver:	
593744	4mm Hex Nut Driver
593745	5mm Hex Nut Driver
593755	5.5mm Hex Nut Driver
593756	6mm Hex Nut Driver
594757	7mm Hex Nut Driver
594758	8mm Hex Nut Driver
594759	9mm Hex Nut Driver
594760	10mm Hex Nut Driver
594761	11mm Hex Nut Driver
594762	12mm Hex Nut Driver
595763	13mm Hex Nut Driver
595764	14mm Hex Nut Driver
Kit Bag	

1400 g CODE : 007960
 12 Sets / 18 Kgs / 1.0 CUFT

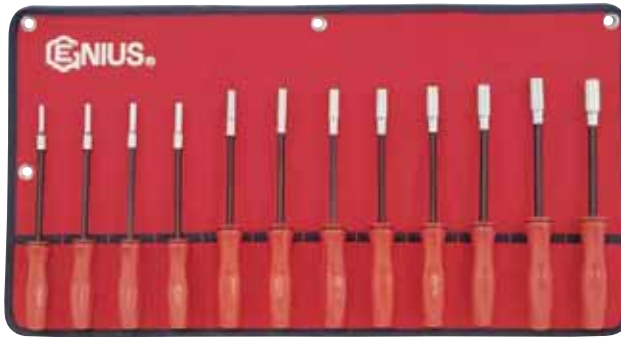

ND-012MD

ND-012MD 12 Piece Metric Long Hex Nut Driver Set

Item No.	Description
Metric Long Hex Nut Driver:	
593844	4mm Long Hex Nut Driver
593845	5mm Long Hex Nut Driver
593855	5.5mm Long Hex Nut Driver
593856	6mm Long Hex Nut Driver
594857	7mm Long Hex Nut Driver
594858	8mm Long Hex Nut Driver
594859	9mm Long Hex Nut Driver
594860	10mm Long Hex Nut Driver
594861	11mm Long Hex Nut Driver
594862	12mm Long Hex Nut Driver
595863	13mm Long Hex Nut Driver
595864	14mm Long Hex Nut Driver
Kit Bag	

1720 g CODE : 010900
 12 Sets / 21 Kgs / 1.2 CUFT



ND-007S

ND-007S 7 Piece SAE Hex Nut Driver Set

Item No.	Description
SAE Hex Nut Driver:	
593712	3/16" Hex Nut Driver
593716	1/4" Hex Nut Driver
594720	5/16" Hex Nut Driver
594722	11/32" Hex Nut Driver
594724	3/8" Hex Nut Driver
594728	7/16" Hex Nut Driver
595732	1/2" Hex Nut Driver
Kit Bag	

940 g CODE : 004630
 20 Sets / 20 Kgs / 1.2 CUFT





ND-007SD

ND-007SD 7 Piece SAE Long Hex Nut Driver Set



Item No.	Description
SAE Long Hex Nut Driver:	
593812	3/16" Long Hex Nut Driver
593816	1/4" Long Hex Nut Driver
594820	5/16" Long Hex Nut Driver
594822	11/32" Long Hex Nut Driver
594824	3/8" Long Hex Nut Driver
594828	7/16" Long Hex Nut Driver
595832	1/2" Long Hex Nut Driver
Kit Bag	

1100 g CODE : 06340
 20 Sets / 23 Kgs / 1.2 CUFT



Metric Hex Nut Drivers (with magnet)

ITEM NO.	Size mm	L2 mm	L1 mm	Length mm	Weight g	PCS 	G.W. KGS	CUFT 	CODE @
593556	6	8	70	165	75	200	16.0	1.60	000780
594557	7	9	70	180	90	160	15.5	1.60	000830
594558	8	9	70	180	90	160	15.5	1.60	000830
594559	9	10	70	180	90	160	15.5	1.60	000830
594560	10	11	70	180	90	160	15.5	1.60	000830
594561	11	11	70	180	90	160	15.5	1.60	000830
594562	12	12	70	180	90	160	15.5	1.60	000830
595563	13	13	70	190	130	120	17.0	1.60	001000
595564	14	14	70	190	130	120	17.0	1.60	001000



SAE Hex Nut Drivers (with magnet)

ITEM NO.	Size Inch	L2 mm	L1 mm	Length mm	Weight g	PCS 	G.W. KGS	CUFT 	CODE @
593516	1/4	6	70	165	75	200	16.0	1.60	000780
594520	5/16	8	70	180	90	160	15.5	1.60	000830
594522	11/32	9	70	180	90	160	15.5	1.60	000830
594524	3/8	10	70	180	90	160	15.5	1.60	000830
594528	7/16	12	70	180	90	160	15.5	1.60	000830
595532	1/2	14	70	190	130	120	17.0	1.60	001000

Metric Long Hex Nut Drivers (with magnet)

ITEM NO.	Size mm	L2 mm	L1 mm	Length mm	Weight g	PCS 	G.W. KGS	CUFT 	CODE @
593656	6	8	150	245	95	200	20.0	1.97	001090
594657	7	9	150	260	120	160	20.5	1.97	001140
594658	8	9	150	260	120	160	20.5	1.97	001140
594659	9	10	150	260	120	160	20.5	1.97	001140
594660	10	11	150	260	120	160	20.5	1.97	001140
594661	11	11	150	260	120	160	20.5	1.97	001140
594662	12	12	150	260	120	160	20.5	1.97	001140
595663	13	13	150	270	160	120	20.5	1.97	001340
595664	14	14	150	270	160	120	20.5	1.97	001340

SAE Long Hex Nut Drivers (with magnet)

ITEM NO.	Size Inch	L2 mm	L1 mm	Length mm	Weight g	PCS 	G.W. KGS	CUFT 	CODE @
593616	1/4	6	150	245	95	200	20.0	1.97	001090
594620	5/16	8	150	260	120	160	20.5	1.97	001140
594622	11/32	10	150	260	120	160	20.5	1.97	001140
594624	3/8	10	150	260	120	160	20.5	1.97	001140
594628	7/16	12	150	260	120	160	20.5	1.97	001140
595632	1/2	14	150	270	160	120	20.5	1.97	001340

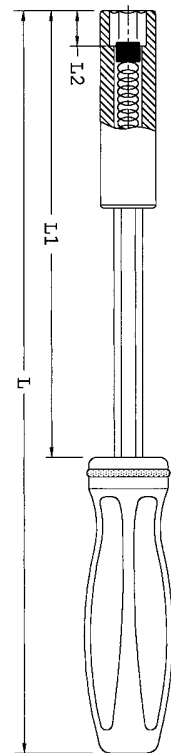

Screwdriver Sets

NM-009M 9 Piece Metric Hex Nut Driver Set

Item No.	Description
Metric Hex Nut Driver with magnet:	
593556	6mm Hex Nut Driver
594557	7mm Hex Nut Driver
594558	8mm Hex Nut Driver
594559	9mm Hex Nut Driver
594560	10mm Hex Nut Driver
594561	11mm Hex Nut Driver
594562	12mm Hex Nut Driver
595563	13mm Hex Nut Driver
595564	14mm Hex Nut Driver
Kit Bag	

 1170 g CODE : 007370
 20 Sets / 24 Kgs / 1.2 CUFT



NM-009M



NM-009MD



NM-009MD 9 Piece Metric Long Hex Nut Driver Set

Item No.	Description
Metric Long Hex Nut Driver with magnet:	
593656	6mm Long Hex Nut Driver
594657	7mm Long Hex Nut Driver
594658	8mm Long Hex Nut Driver
594659	9mm Long Hex Nut Driver
594660	10mm Long Hex Nut Driver
594661	11mm Long Hex Nut Driver
594662	12mm Long Hex Nut Driver
595663	13mm Long Hex Nut Driver
595664	14mm Long Hex Nut Driver
Kit Bag	

 1430 g CODE : 010070
 12 Sets / 18 Kgs / 1.0 CUFT



NM-006SD 6 Piece SAE Long Hex Nut Driver Set

Item No.	Description
SAE Long Hex Nut Driver with magnet:	
593616	1/4" Long Hex Nut Driver
594620	5/16" Long Hex Nut Driver
594622	11/32" Long Hex Nut Driver
594624	3/8" Long Hex Nut Driver
594628	7/16" Long Hex Nut Driver
595632	1/2" Long Hex Nut Driver
Kit Bag	

 940 g CODE : 006640
 20 Sets / 20 Kgs / 1.2 CUFT

NM-006S 6 Piece SAE Hex Nut Driver Set

Item No.	Description
SAE Hex Nut Driver with magnet:	
593516	1/4" Hex Nut Driver
594520	5/16" Hex Nut Driver
594522	11/32" Hex Nut Driver
594524	3/8" Hex Nut Driver
594528	7/16" Hex Nut Driver
595532	1/2" Hex Nut Driver
Kit Bag	

 770 g CODE : 004840
 20 Sets / 17 Kgs / 1.0 CUFT



NM-006S



NM-006SD